

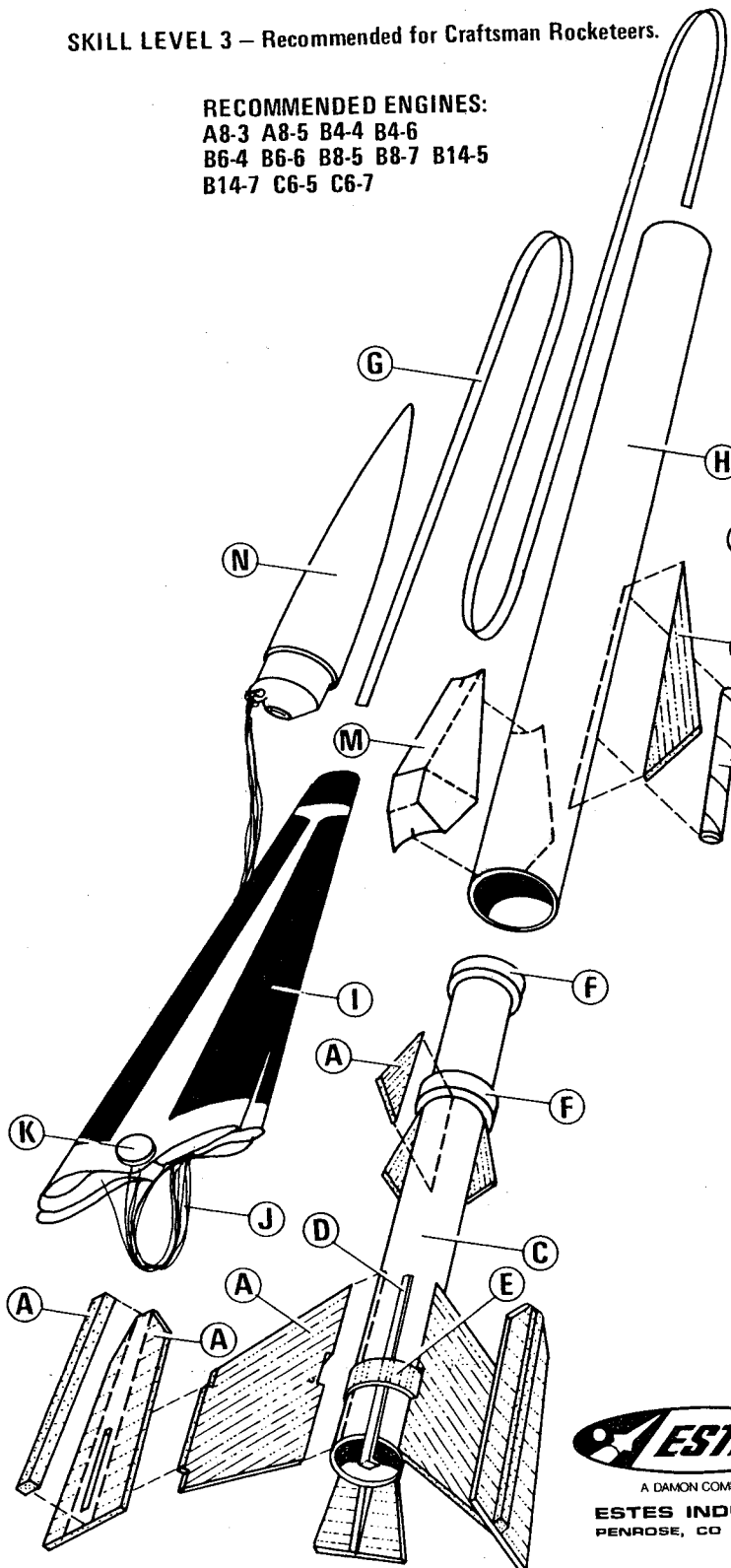

STARBLAZER-X20

SKILL LEVEL 3 – Recommended for Craftsman Rocketeers.

RECOMMENDED ENGINES:
A8-3 A8-5 B4-4 B4-6
B6-4 B6-6 B8-5 B8-7 B14-5
B14-7 C6-5 C6-7



BEFORE YOU START

Read all instructions before beginning work on your model. Make sure you have all parts and materials. When you are thoroughly familiar with the assembly procedure, begin construction. Check off each step as you complete it. In each step, test-fit the parts together before applying any glue. If some part doesn't fit properly, sand lightly or build up as required for precision assembly.

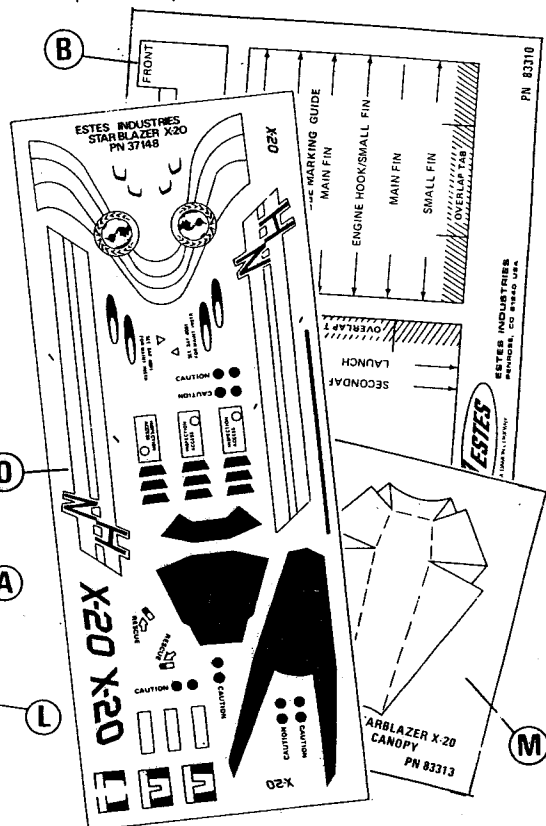

PARTS LIST KIT NO. 1342

A	1	Balsa Fin Sheet (type BF-1342)	32346
B	1	Pattern Sheet (type SP-1342)	83310
C	1	Engine Tube (type BT-20D)	30322
D	1	Engine Hook (type EH-2)	35025
E	1	Hook Retainer Ring (type HR-20)	30168
F	2	Adapter Rings (type AR-2050)	30164
G	1	Shock Cord (type SC-1)	85730
H	1	Large Body Tube (type BT-50W)	30372
I	1	Parachute (type PK-12)	85564
J	1	Shroud Line (type SLT-72)	38237
K	1	Tape Discs (type TD-3F)	38406
L	1	Launch Lug (type LL-2A)	38175
M	1	Printed Canopy	83313
N	1	Nose Cone (type PNC-50Y)	71009
O	1	Decal (type KD-1342)	37148

TOOLS AND MATERIALS

In addition to the parts included in this kit you will need white glue (Titebond, Elmer's, or similar household white glue is recommended.), scissors, pencil, ruler, fine and extra-fine grit sandpaper, sanding sealer, masking tape, a medium size modeling paint brush, modeling knife with sharp blade, white enamel spray paint, light metallic blue enamel spray paint, yellow enamel spray paint, and a bottle of chrome silver enamel paint.



A DAMON COMPANY
ESTES INDUSTRIES
PENROSE, CO 81240 USA

ASSEMBLY INSTRUCTIONS

1

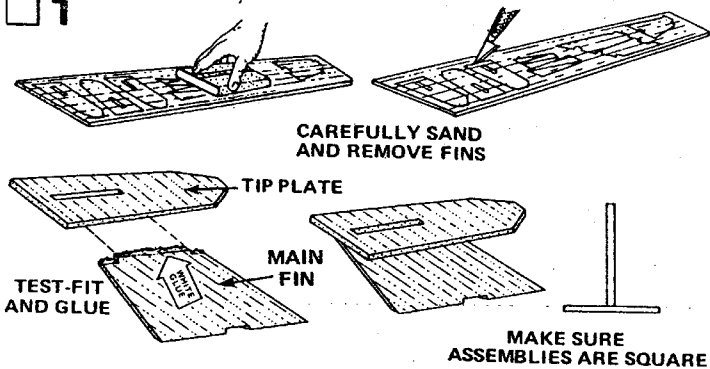

Sand both sides of the balsa fin sheet (part A) with extra-fine sandpaper until smooth. Carefully remove the main fins and tip plates. Use a sharp knife or single edge razor blade to free the edges before removal. Sand the edges of the fin pieces slightly to remove any rough spots, but leave the edges square and sharp. Test-fit the main fin and tip plates together as shown. If tab will not fit smoothly into slot then widen or lengthen the slot with a sharp knife. Glue a main fin to each tip plate as shown. Make sure the assemblies are square, then set them aside to dry.

2

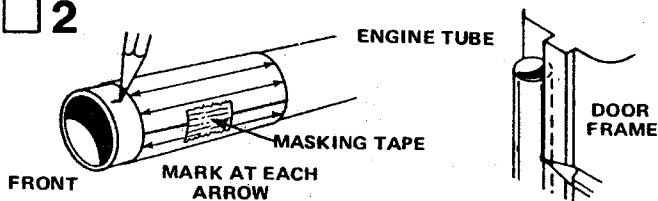

Cut out the engine tube marking guide from the pattern sheet (part B). Wrap it around the middle of the engine tube (part C) and mark the tube at each arrow point, front and rear. Draw straight lines connecting matching front and rear marks by placing the body tube against the inside edge of a door frame as shown. Draw lines the full length of the tube.

3

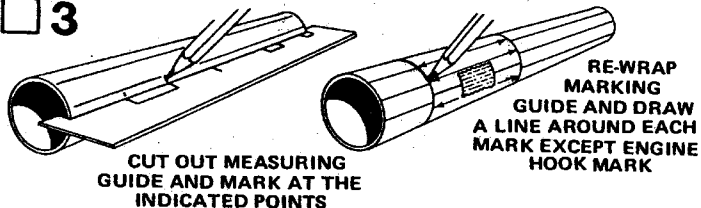

Cut out the measuring guide from the pattern sheet and use it to mark the engine tube at the points indicated. Position the marks halfway between two fin lines, re-wrap engine tube marking guide around the engine tube, slide the guide up to a mark and draw a line all the way around the tube. Do this for all the marks except the engine hook mark.

4

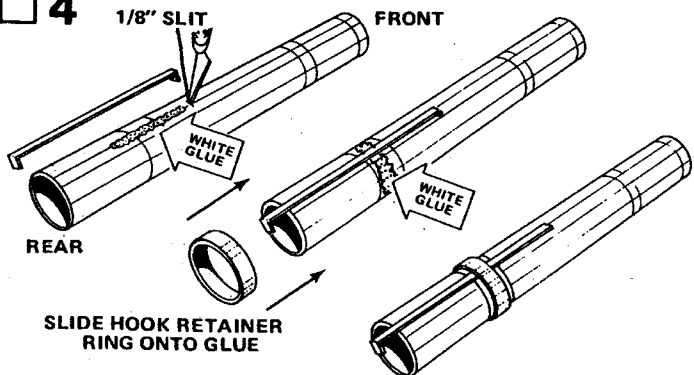

Cut a 1/8" long slit in the engine tube at the engine hook mark on its alignment line as shown. Apply a 1" long line of glue to the tube

running rearward from the slit. Push one end of the engine hook (part D) into the slit and press the main part of the hook into the glue. Apply a line of glue around the tube between the two hook retainer ring location marks. Slide the hook retainer ring (part E) onto the tube, over the engine hook, and onto the glue, centering it between the two marks.

5

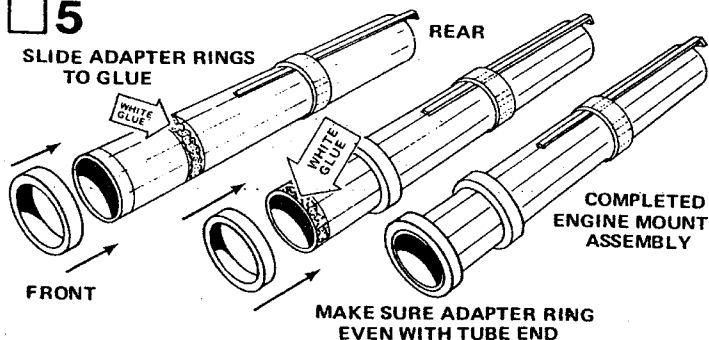

Check the fit of the adapter rings (part F) on the engine tube. If necessary, sand their insides until they make a smooth fit. Glue the adapter rings in place on the engine tube. Glue the first ring so its rear end is even with the location mark. Glue the other ring on the tube so its front is even with the front of the tube.

6

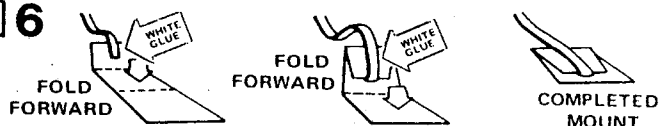

Cut out the shock cord mount from the pattern sheet. Crease it on the dotted lines by folding. Spread glue on the first section (1) and lay the end of the shock cord (part G) into the glue. Fold over and apply glue to the back of the first section and the exposed part of section 2. Fold over again and clamp the unit together with your fingers until the glue sets.

7



Apply glue to the inside of the large body tube (part H) at one end over an area about 1" to 2" from the end. The glued area should be the same size as the shock cord mount. Press the mount into the glue as shown and hold it until the glue sets.

8

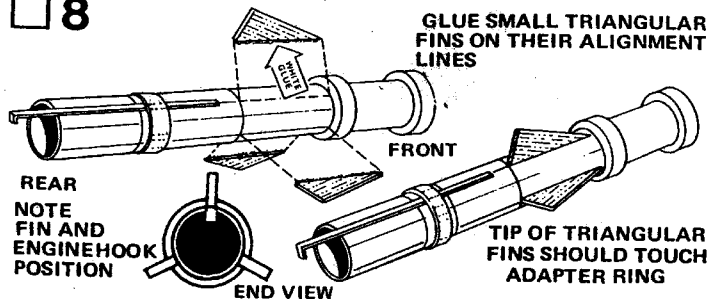

Carefully remove the small triangular fins from the balsa sheet. Sand their edges square and smooth. Glue the small triangular fins to their alignment lines on the engine tube so the front tip of the fin is positioned against the adapter ring as shown. One of the small triangular fins should be located on the same alignment line as the engine hook.

9

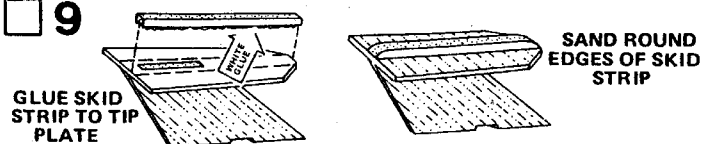

Remove the three skid strips from the balsa sheet. Sand their edges square and smooth. Glue one of the skids centered lengthwise on the tip plate as shown. Glue the remaining two skids to the other two fin and tip plate assemblies. Sand round the tips of the skids, after the glue has set, as shown. Make sure the front edge of the tip plate is still square.

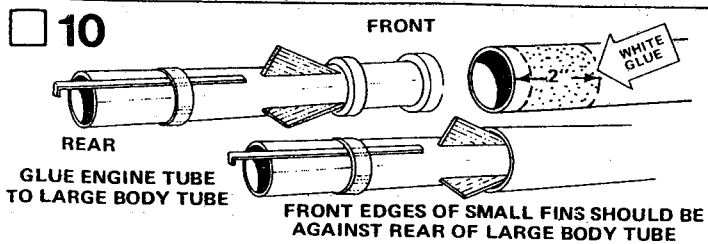

Glue the engine tube to the large body tube at the end opposite the shock cord mount. Smear glue around the inside of the large body tube to cover an area about 1-1/2" to 2" from the end of the tube. Immediately insert the engine tube assembly, pushing it in with one smooth motion until the rear edge of the large body tube is just touching the front edges of the three small triangular fins as shown.

CONSTRUCTION TIP: When gluing fins on the body, first apply a line of glue to the root edge (the edge that attaches to the body). Let this glue set a moment, then rub it into the wood with your finger. Do this to all the fins. Then apply another line of glue to a fin, hold it a moment and press it firmly into place on the body using the fin alignment lines to make sure the fin is straight.

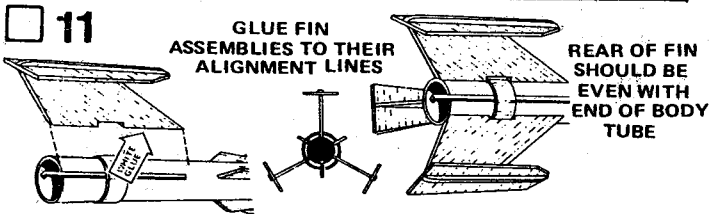

Glue the main fin assemblies to the engine tube. The rear of each main fin should be even with the rear of the engine tube, with the notch approximately centered over the hook retainer ring. Be careful to center the main fins on their alignment lines so all fins are evenly spaced around the body as shown in the rear view illustration.

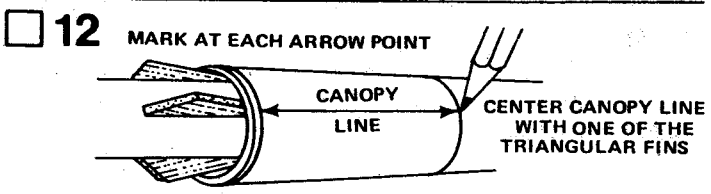

Cut out the body tube marking guide from the pattern sheet. Wrap it around the body tube so the canopy alignment line is centered on one of the small triangular fins as shown. Mark the body tube at each arrow point, front and rear. Draw straight lines connecting each pair of front and rear marks and extending the length of the tube. Use procedure shown in step 3.

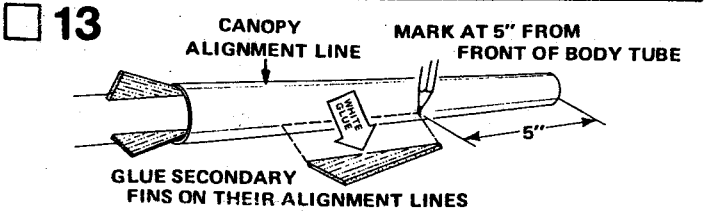

Measure 5" from the front of the rocket body tube/nose cone joint and place a mark on each secondary fin alignment line. Remove the remaining two fins from the balsa fin sheet. Sand the edges of the fins square. Glue these two secondary fins on their alignment lines so the front tip of the fins is on the 5" mark as shown.

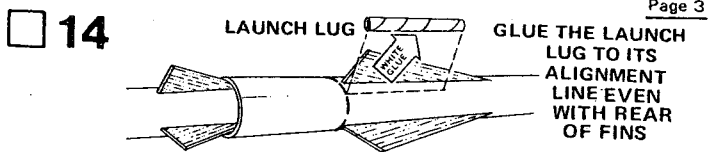

Glue the launch lug (part L) to the main body tube on its alignment line. The rear of the lug should be even with the rear of the secondary fins. Sight through the lug as you position it. Make sure it is straight on the body tube.

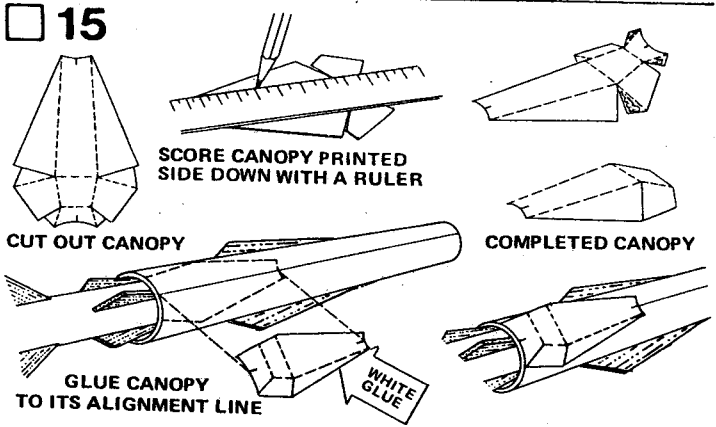

Cut the canopy, (part M) from the pattern sheet along the solid cut lines. Lay canopy printed side down and score with a pencil and ruler as shown. Fold canopy on dotted lines and glue tabs to inside of canopy. Clamp tabs together with your fingers until glue sets. Apply a small amount of glue around inside edge of canopy as shown. Glue canopy to body tube with the rear of the canopy touching the rear edge of the body tube, and match the small marks on the canopy with the alignment line as shown. Clamp sides of canopy to the sides of the body tube with your fingers until glue sets.

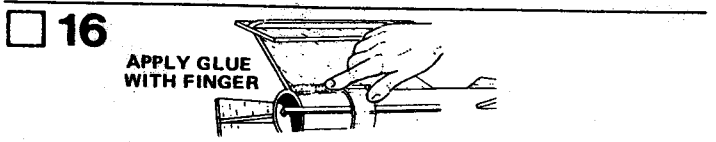

Apply a glue reinforcement to each fin joint. Hold the rocket level. Apply a line of glue to both sides of each fin joint. Smooth out the glue with your finger. Keep the rocket level until the glue dries.

PAINTING AND DETAILING

17 When all the glue on the outside of the model is dry, apply at least two coats of sanding sealer to the fins. Let dry and sand lightly between coats. Do this until the wood looks and feels smooth. Paint the entire model white. When white paint is completely dry, mask off the front section of the rocket 1-3/4" from the body tube/nose cone joint. Paint model with light metallic blue spray paint. When paint is dry unmask the front section to expose the white section on the rocket body. Next paint the nose cone (part N) yellow. When all paint is dry, use a brush to paint the top surface of the skids, on the fin plates, chrome silver.

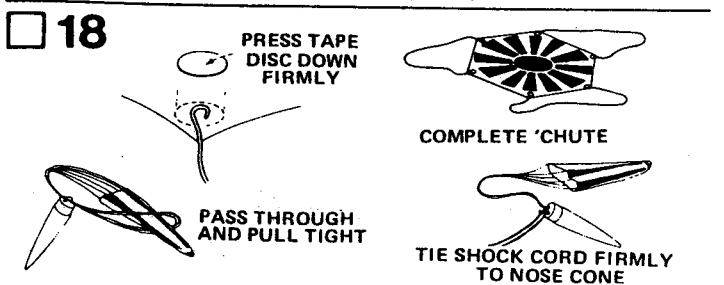

Cut out the parachute (part I) on its edge lines. Cut three 24" lengths of shroud line (part J). Attach line ends to the top (printed side) of the parachute with tape discs (part K) as shown. Pass the

shroud line loop ends through the nose cone eyelet. Then pass the parachute through the loop ends and pull the lines tight against the eyelet. "Set" the knot with a drop of glue. Tie the free end of the shock cord to the eyelet with a double knot. Pack chute and shock cord into rocket body. Slide nose cone into place.

DECAL PLACEMENT

19

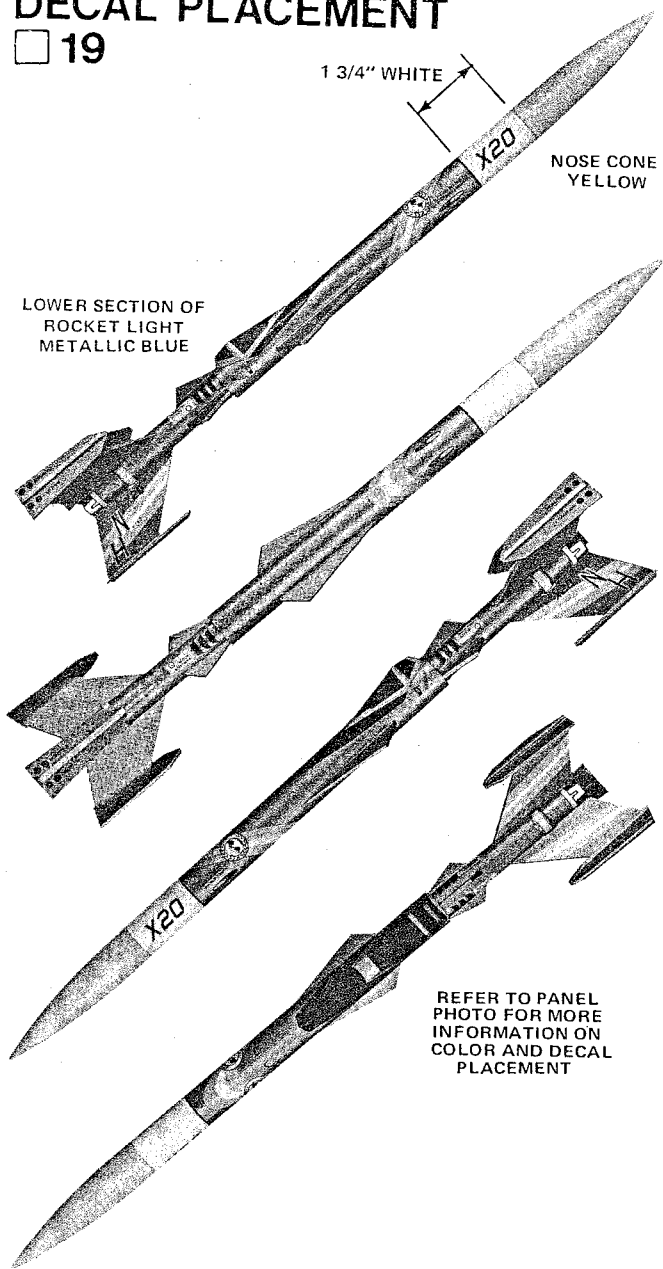

LOWER SECTION OF ROCKET LIGHT METALLIC BLUE

NOSE CONE YELLOW

REFER TO PANEL PHOTO FOR MORE INFORMATION ON COLOR AND DECAL PLACEMENT

When all paint is thoroughly dry, apply decals (part O) as shown in photo. Cut out a decal along the printed design and dip in lukewarm water for 20 seconds. Slip the decal off the backing sheet and onto your model. Blot away excess water. For best results, let model dry overnight and apply a coat of clear spray to protect the decals.

LAUNCHING COMPONENTS

To launch your rocket you will need the following items:
 An Estes model rocket launch system
 Parachute recovery wadding (Estes Cat. No. 2274)
 Recommended Engines: A8-3 (first flight), A8-5, B4-4, B4-6, B6-4, B6-6, B8-5, B8-7, B14-5, B14-7, C6-5, C6-7.

Be sure to follow the HIAA-NAR* Model Rocketry Safety Code when carrying out your model rocketry activities.

*HIAA -- Hobby Industry Association of America
 NAR -- National Association of Rocketry

COUNTDOWN CHECKLIST

T-14

Pack 4 or 5 squares of loosely crumpled recovery wadding into the rocket body.

T-13

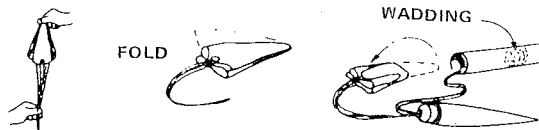

Gather the parachute as shown, then fold into a triangular shape. Fold again and insert into rocket body.

NOTE: DO NOT pack parachute until you are actually ready to launch. For maximum parachute reliability, lightly dust the chute with ordinary talcum powder before each flight, especially in cold weather.

T-12

Pack parachute, shroud lines, and shock cord neatly into rocket body. Slide nose cone into place.

Nose cone should separate easily from rocket body tube, but should not be extremely loose. If fit is too tight, sand inside of body tube and shoulder of nose cone with fine sandpaper. If fit is too loose, add a wrapping of transparent tape or masking tape to the shoulder of nose cone.

T-11



Select an engine and install an igniter as directed in the engine instructions. Use an A8-3 engine for your first flight.

T-10

Insert engine into rocket engine mount. Engine hook must latch securely over end of the engine.

T-9

Disarm the launch panel -- REMOVE SAFETY KEY!

T-8

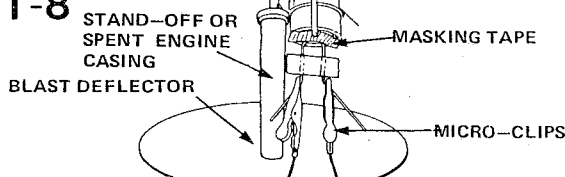

Slide launch rod through rocket launch lug and place rocket on launch pad. Make sure the rocket slides freely on launch rod. Clean the micro-clips and attach them to the igniter wires. Arrange the clips so they do not touch each other or the metal blast deflector. Attach clips as close to engine as possible.

T-7

Clear the launch area, alert recovery crew and trackers. Check for low flying aircraft and unauthorized persons in the recovery area.

T-6

Arm the launch panel -- INSERT SAFETY KEY!

-5-4-3-2-1-LAUNCH!!

Repeat Countdown Checklist for each flight.

MISFIRE PROCEDURE

Occasionally the igniter will heat and burn into two pieces without igniting the engine. This is almost always caused by a failure to install it correctly. REMOVE SAFETY KEY from launch panel, remove the model, clean the igniter residue from the engine nozzle, and install a new igniter. Repeat the Countdown Checklist.

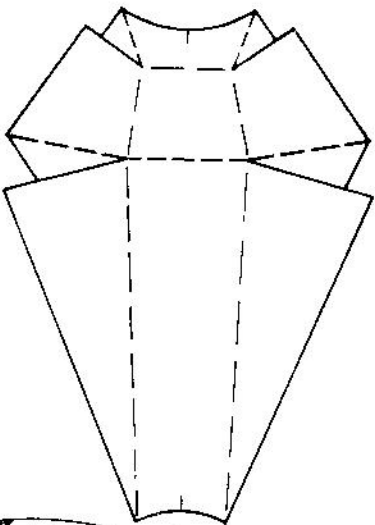

**STARBLAZER X-20
CANOPY**

PN 83313



ESTES INC.
PENROSE, CO

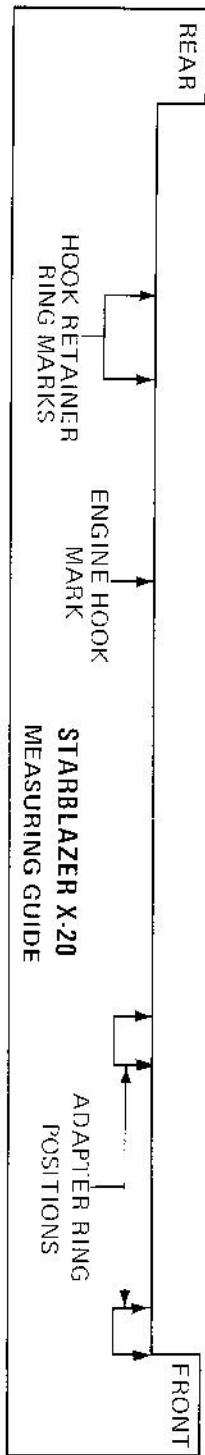
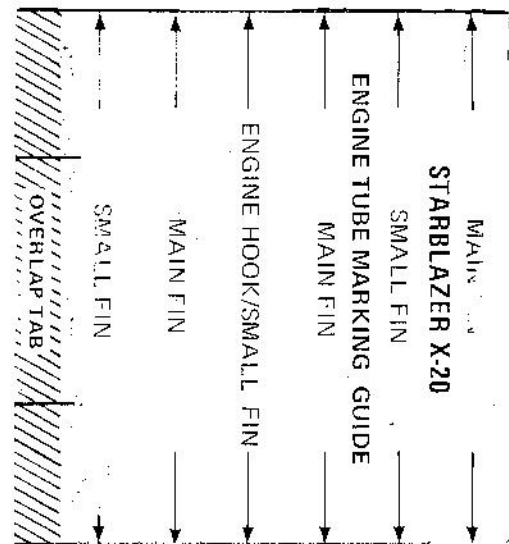
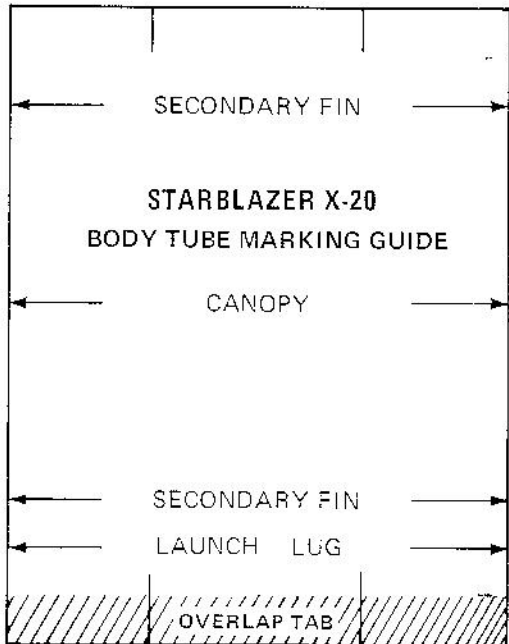
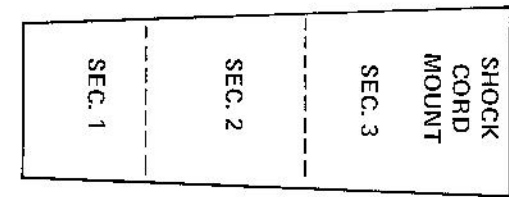

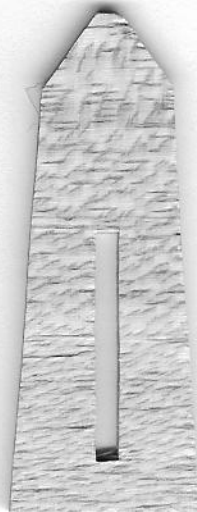
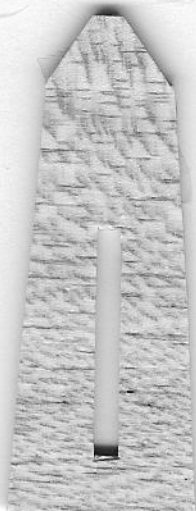
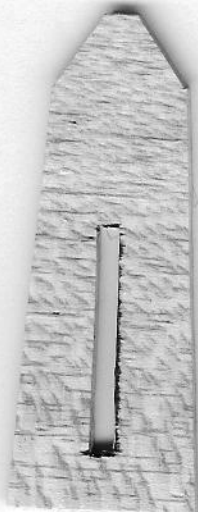
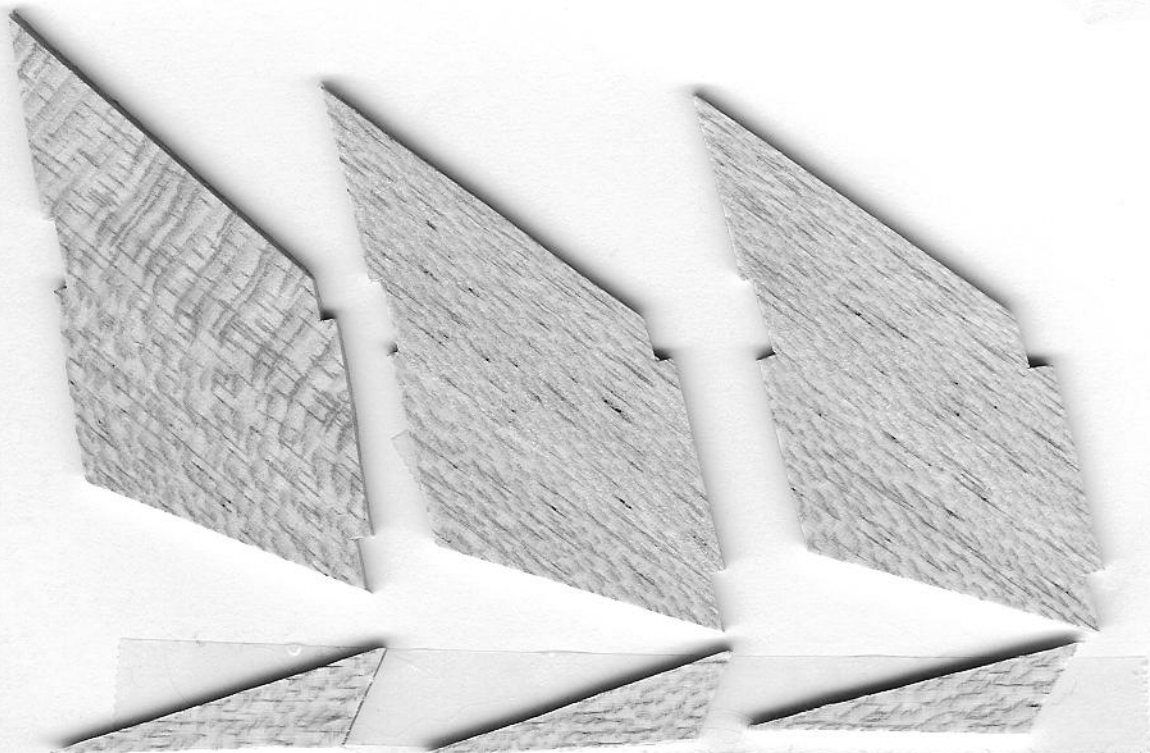

ESTES INDUSTRIES
STAR BLAZER X-20
PN 37148

X-20

HM



SEE SAF-8081
FOR MAINT. INSTR.

SEE SAF-8081
FOR MAINT. INSTR.

CAUTION ● ●

CAUTION ● ●



NH

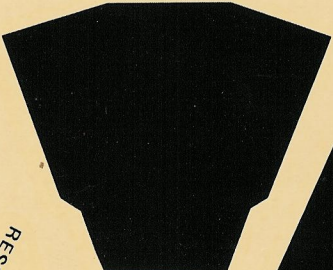

RESCUE

RESCUE

CAUTION ● ●

CAUTION ● ●

CAUTION ● ●
CAUTION ● ●

X-20 X-20



X-20



X-20

NH



SEE SAF -8081 FOR MAINT. INSTR.

SEE SAF -8081 FOR MAINT. INSTR.

CAUTION

CAUTION

INSPECTION ACCESS

INSPECTION ACCESS

INSPECTION ACCESS

NH

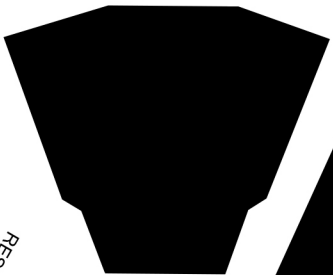

RESCUE

RESCUE

CAUTION

CAUTION

CAUTION

CAUTION



X-20

X-20 X-20



STARBLAZER X-20

FLYING MODEL ROCKET

SKILL LEVEL 3

Imagine a messenger of outer space. A Messenger 3 Team. A Starblazer in the vast presence of the U.S. Earth Forest, the Starblazer X-20 is perfect for daily educational emergency interest missions in Earth's outer space. Armed with 100-barrel and pressure for the ultimate independent mission time it has built range capability at speeds of over 8,000 M.P.H. and speed features include built-in, plastic nose cone, quick release engine mount and multi-SS. Great performance and exciting sounding with 17" diameter.

Specifications:
Length: 18.25" (46.2 cm)
Diameter: .875" (22.3 cm)
Height: 1.12" (28.1 cm)
Recommended Engines:
A6-3 (F50) F50C, A6-3
A6-3 (F50) F50C, A6-3
A6-3 (F50) F50C, A6-3
A6-3 (F50) F50C, A6-3
A6-3 (F50) F50C, A6-3

**Flies
Over
800
Feet!**

This is a hobby kit requiring assembly. Recommended for ages 10 to adult. Engines, launch system, glue and finishing supplies are not included. Adult supervision is suggested for those under 12 years of age when flying model rockets.



ESTES INDUSTRIES
MORGAN, MD 21051 USA



1342