

# ATTACK CRAFT ORION

## FLYING MODEL ROCKET

**SKILL LEVEL 3**

1-Beginner 2-Intermediate 3-Craftsman  
4-Advanced 5-Expert

- Unique Space Fighter
- Exotic Plastic Nose Cone
- 12" Parachute Recovery
- Die-Cut Balsa Fins
- 3-Color Kit Decal
- Quick-Release Engine Mount

**Flights  
Over  
1,200'**

**Length:**  
12.32" (31.29cm)

**Diameter:**  
.976" (24.8mm)

**Weight:**  
1.41 oz. (39.7g)

**Engine Types:**  
A8-3 (First Flight),  
B4-4, B6-4, B8-5,  
C6-5

This is a hobby kit requiring assembly. Recommended for ages 10 to adult. Engines, launch system, glue and finishing supplies are not included. Adult supervision is suggested for those under 12 years of age when flying model rockets.

#1374



ESTES INDUSTRIES  
PENROSE, CO 81240 USA

# ATTACK CRAFT ORION

Skill Level 3—Recommended For Craftsmen Rocketeers

## BEFORE YOU START

Read each step and study the accompanying drawings before doing any of the work called for in that step. Make sure you have all parts and materials. Check off each step as you complete it. Always test-fit parts together before applying glue. It will sometimes be necessary to sand edges of rings, tubes, etc. to obtain a proper fit. If you are in doubt about the relative size or location of some parts, refer back to this exploded view drawing for clarification. Adequate glue joints are very important for a flying model rocket. Follow the instructions carefully in this regard.

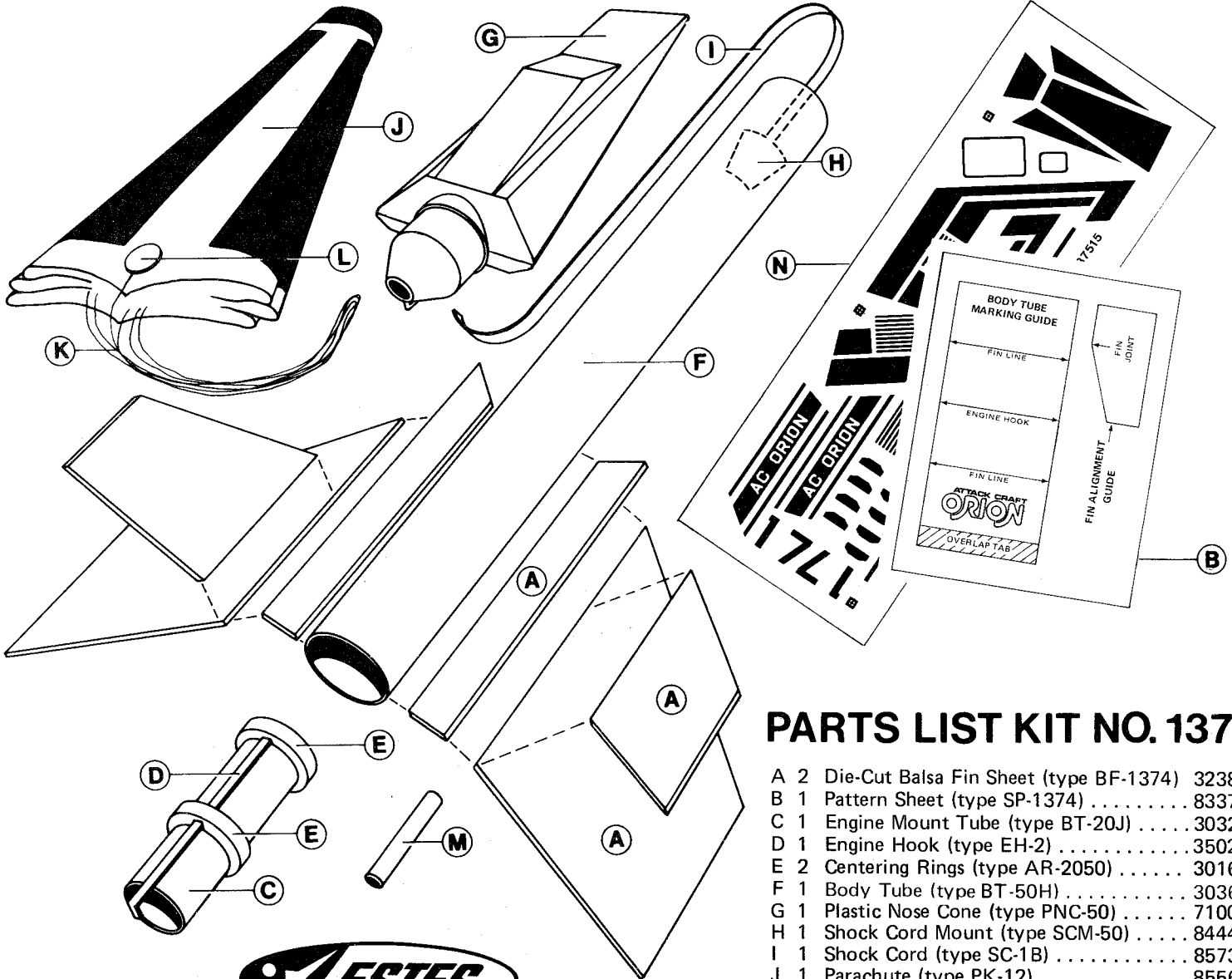

A DAMON COMPANY

**ESTES INDUSTRIES**  
PENROSE, CO 81240 USA

## PARTS LIST KIT NO. 1374

A	2	Die-Cut Balsa Fin Sheet (type BF-1374)	32383
B	1	Pattern Sheet (type SP-1374)	83379
C	1	Engine Mount Tube (type BT-20J)	30326
D	1	Engine Hook (type EH-2)	35025
E	2	Centering Rings (type AR-2050)	30164
F	1	Body Tube (type BT-50H)	30360
G	1	Plastic Nose Cone (type PNC-50)	71000
H	1	Shock Cord Mount (type SCM-50)	84444
I	1	Shock Cord (type SC-1B)	85734
J	1	Parachute (type PK-12)	85564
K	1	Shroud Line (type SLT-72)	38237
L	1	Tape Disc Set (type TD-3F)	38406
M	1	Launch Lug (type LL-2A)	38175
N	1	Decals (type KD-1374)	37515

RECOMMENDED ENGINES: A8-3

B4-4 B6-4 B8-5 C5-3 C6-5

First Flight A8-3

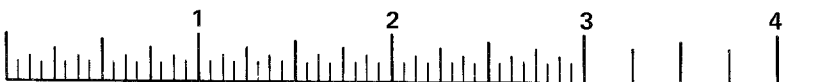

## TOOLS AND MATERIALS

In addition to the parts included in this kit you will need: Scissors, pencil, ruler, fine or extra-fine grit sandpaper, sanding sealer, a medium-size modeling paint brush, modeling knife with sharp blade, light gray enamel spray paint, masking tape, and household white glue or resin glue (Elmer's, Titebond, or similar). Other types of glue are not recommended.

# ASSEMBLY INSTRUCTIONS

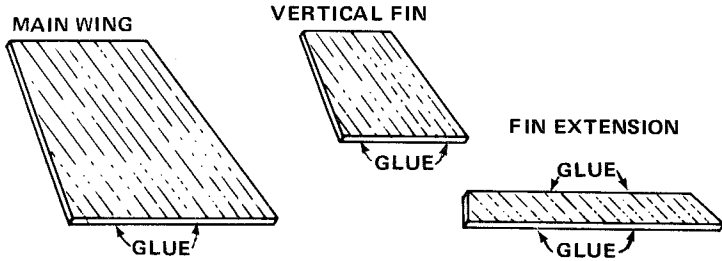
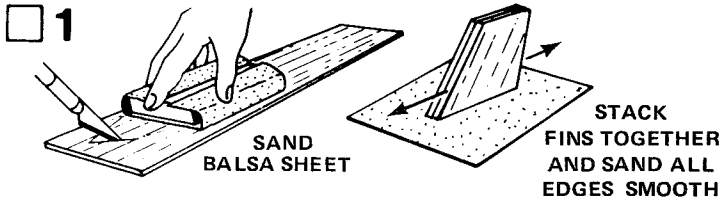

Fine-sand the balsa die-cut sheets (part A). Free the fin edges with a sharp knife, then carefully remove the die-cut fins from the sheets. Stack the fins together into groups as shown and sand all of the edges flat. Lightly sand both sides of each fin. Rub a line of glue into the root edge of each of the fins as shown. Allow the glue to dry completely. Lightly sand the glued edges so that they are smooth.

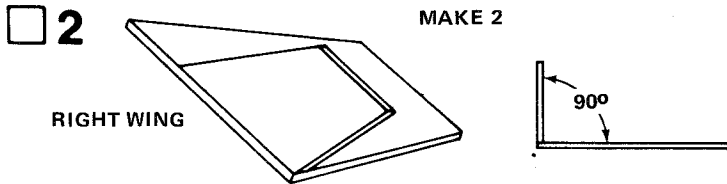

Glue the vertical fins to the main wings as shown. Position the vertical fin so that its side is even with the edge of the main wing and the rear edges are even. Adjust the vertical fins so that they project straight away from the main wings. Be sure to make a left wing assembly and a right wing assembly. Allow glue to dry.

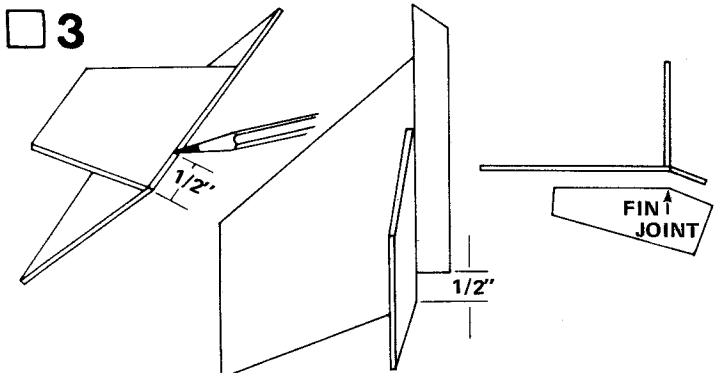

Mark the two main wings 1/2" from the rear. Cut out the fin alignment guide from the pattern sheet (part B). Glue the fin extensions to the main wings so that the longest side is against the main wing and the rear edge is at the mark. Use the guide (part B) to position the wing extensions at the proper angle. NOTE: Check the angle of the wings several times while the glue is drying so that the glue will not set with the wings at the wrong angle.

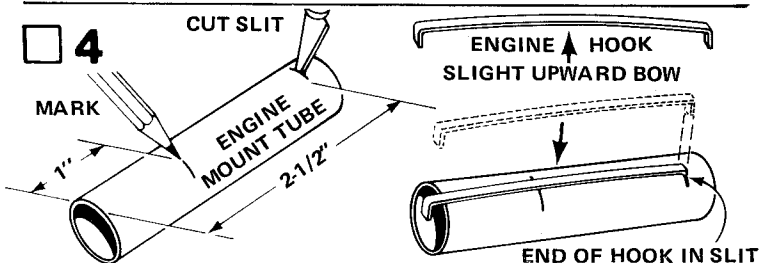

Mark the engine mount tube (part C) at 1" and 2-1/2" from one end. Cut a 1/8" long slit at the 2-1/2" mark. Gently bend the engine hook (part D) so that it bows upward very slightly in the

middle. (Study the drawing — Don't bend the wrong way.) Insert one end of the engine hook into the slit in the tube.

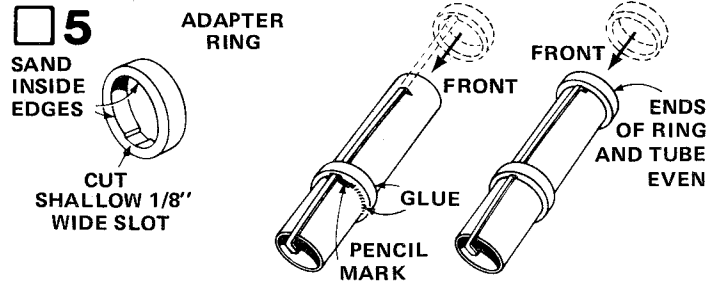

Sand the inside edges of the two centering rings (part E) to remove burrs. The rings should slide easily onto the engine mount tube. Cut a very shallow 1/8" wide slot inside one centering ring so it will fit over the engine hook. Slip the ring onto the front end of the engine mount tube and slide it down to the 1" mark. Make sure the engine hook runs straight down the tube, then apply glue to both sides of this centering ring. Apply glue around the front end of the engine mount tube and slide the remaining centering ring into place (front of ring even with the end of the tube).

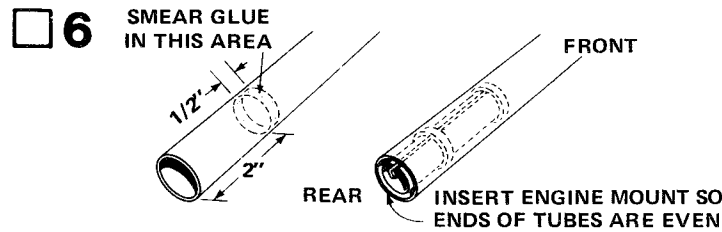

The engine mount unit will be pushed into place so that the rear of the engine mount tube (end with engine hook projecting) is even with the rear of the body tube. Test-fit the engine mount unit several times by smoothly inserting and removing it. Sand if necessary to assure a smooth fit. Once this can be smoothly and easily done, remove the engine mount unit. Apply a ring of glue around the inside of the rear of the main body tube (part F) about 2" to 2-1/2" from the end of the tube. Make certain that the engine hook is to the rear and insert the engine mount unit with one smooth motion. Do not pause, or the glue may "lock" with the engine mount unit in the wrong position.

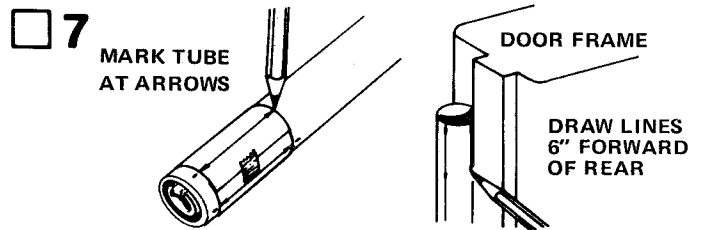

Cut out the body tube marking guide from the pattern sheet and wrap it around the body tube (part F). Align the guide marks and tape the guide together. Turn the guide so that the engine hook is lined up with the engine hook mark. Mark the body tube at each of the arrow points. Remove the guide. Draw straight lines connecting each pair of marks. A door frame inside edge can be used as a guide as shown. Extend the lines about 4" forward from the rear of the tube.

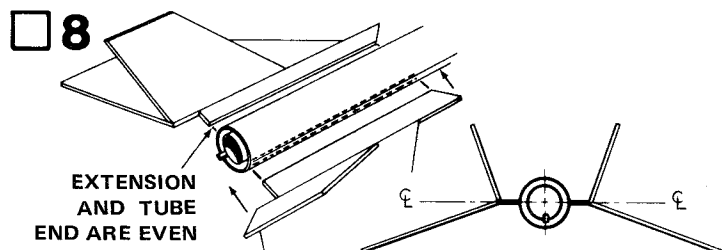

Glue the wing assemblies to the body tube on the alignment lines so that the rear of the wing extensions are even with the rear of the body tube. Adjust the units so that they project straight away from the body tube as shown. Do not set the rocket on its fins while the glue is wet.

9

**CLEAR EYELET**

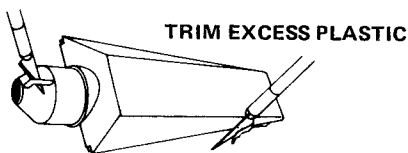

**TRIM EXCESS PLASTIC**

Trim or sand any excess plastic from around the sides of the nose cone (part G). Use a sharp knife to remove any excess plastic from the inside of the molded eyelet at the rear of the nose cone. Wash the nose cone with lukewarm soapy water, rinse well, and dry.

10

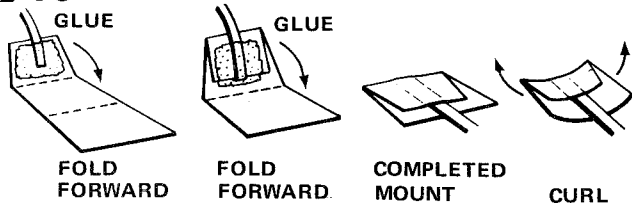

Cut out the shock cord mount (part H). Fold on dotted lines, then unfold and apply glue to Section 1. Lay the end of the shock cord (part I) into the glue. Fold over and apply glue to the back of Section 1 and the exposed portion of Section 2. Fold again to complete mount. Curl the edges of the mount up so it will match the contour of the body tube and hold with your fingers until the glue sets.

11

**SET BACK TO ALLOW FOR NOSE CONE**

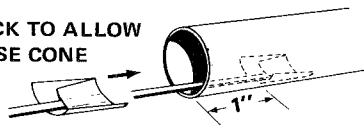

Use a finger or stick to apply glue to the inside of the front of the body tube, 1" to 2" from the front of the tube. Press the shock cord mount firmly into position in glue far enough from the front edge of the tube to allow clearance for the nose cone to fit into place. To insure a good bond use a stick or your finger to smear a film of glue over the mount and surrounding area in the body tube.

12

**APPLY THIN LINE OF GLUE TO JOINT**

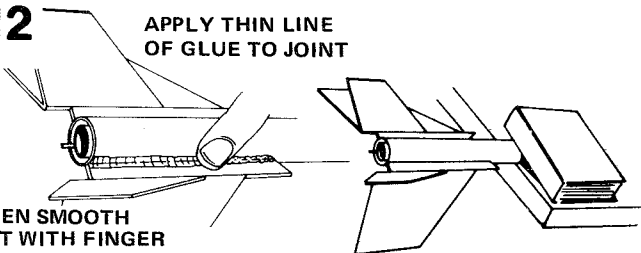

**THEN SMOOTH OUT WITH FINGER**

When the glue on the fin joints has dried, apply a glue reinforcement to each fin/body tube joint. Holding the model level, apply a line of glue to both sides of each joint. Smooth out the glue with your finger. **IMPORTANT** – Support rocket on table edge as shown until the glue dries.

13

**PRESS DOWN FIRMLY**

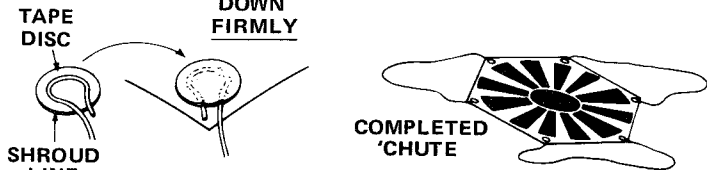

**COMPLETED 'CHUTE'**

**PASS THROUGH AND PULL TIGHT**

**TIE SHOCK CORD FIRMLY TO NOSE CONE**

Cut out the parachute (part J) on its edge lines. Cut three equal lengths of shroud line (part K). Attach line ends to the top of the parachute with tape discs (part L) as shown. Form a small loop

in the end of a shroud line. Holding loop, gently center loop inside tape disc on the sticky side. Then carefully press tape disc onto its proper place on the top of the parachute. Firmly press the tape disc into place until both tape disc and parachute material are molded around the shroud line loop. Repeat for other shroud line ends and tape discs. Pass the shroud line loops through the loop on the nose cone. Pass the parachute through the loop ends and pull the lines tight against the nose cone. Tie the free end of the shock cord firmly to the nose cone loop. A square knot or strong double knot should be used.

14

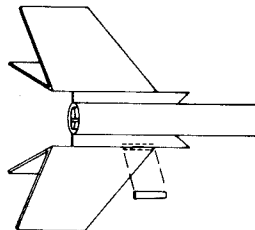

Glue the launch lug (part M) to the underside of one of the wing assemblies. Position the launch lug so that it runs straight along the fin joint and the front of the launch lug is even with the front of the wing.

15

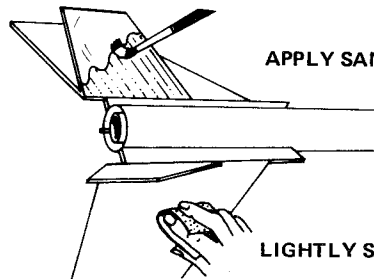

**APPLY SANDING SEALER**

**LIGHTLY SAND ALL FINS**

Proper application of sanding sealer makes the rocket look better and reduces drag so that the rocket will fly higher. However, this step is not essential to make a safe, attractive rocket. Apply a coat of sanding sealer to each fin. When sealer is dry, lightly sand all the sealed surfaces. Repeat sealing and sanding process until balsa grain is filled and smooth.

**PAINTING AND DETAILING**

16

**USE ROLLED PAPER FOR ROCKET HOLDER**

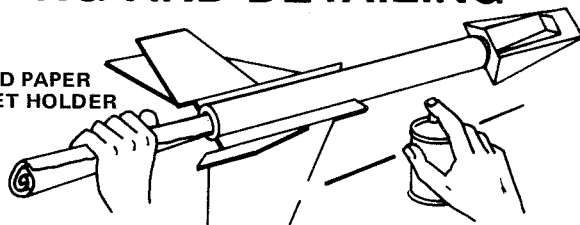

After the sanding sealer is completely dry, paint the entire model light gray. Follow instructions on the spray can for best results. We recommend spray enamel. Do not paint the model with lacquer paint. Shake can before spraying. Hold the can straight up and spray in long, smooth "strokes". Spray the model with several light, dry mist coats of paint to avoid "runs". Shake can periodically. To obtain a gloss, final coat should be applied slightly heavier. Let this coat dry overnight. Paint the insides of the laser cannons flat black. Be sure paint is completely dry before applying decals.

**DECAL PLACEMENT**

17

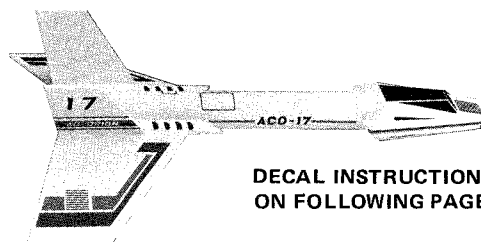

**DECAL INSTRUCTIONS ON FOLLOWING PAGE**

**CAREFULLY CUT OUT  
CANOPY SECTIONS AND  
APPLY INDIVIDUALLY**

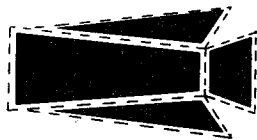

When all paint is dry, apply the decals (part N) in the positions shown. (A) Cut only one decal at a time from sheet. (B) Submerge decal in lukewarm water until decal slides on backing paper (usually 15 to 30 seconds). (C) Gently slide decal from backing paper onto model. (D) Move decal into exact position and carefully blot away excess water with a soft cloth. (E) If the decal "sticks" before you have it in position, apply water over the decal with a brush. This will permit the decal to be moved. (F) Smooth out all wrinkles and air bubbles before the decal dries. We recommend that the completed model be sprayed with Testor's "Dull-Cote". This is a clear flat spray paint that kills the decal shine and protects the model's finish.

## LAUNCHING COMPONENTS

To launch your rocket you will need the following items:

- An Estes model rocket launching system
- Flameproof recovery wadding (Estes Cat. No. 2274)
- Estes A8-3, B4-4, B6-4, B8-5, C5-3, or C6-5 model rocket engines. Use an A8-3 engine for your first flight.

Be sure to follow the HIAA-NAR\* Model Rocket Safety Code when carrying out your model rocket activities.  
\*HIAA - Hobby Industry Association of America  
NAR - National Association of Rocketry

## COUNTDOWN CHECKLIST

### T-13

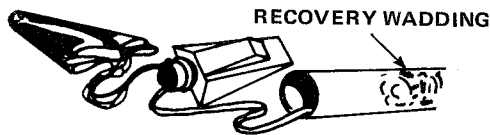

Pack 4 or 5 squares of loosely crumpled recovery wadding into the body tube. Usually this will fill the body tube for a distance equal to about 1-1/2 times its diameter.

### T-12

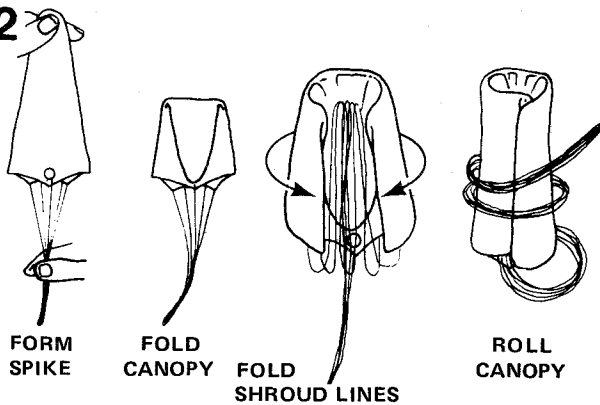

Hold the parachute at its center and pass the other hand down it to form a "spike" shape. Fold this spike in half. Fold shroud lines back along parachute and then back down to lower edge of parachute to reduce length of shroud line "left over". Roll parachute into tube shape to fit easily into body. Any remaining shroud line should be loosely wrapped around parachute. Pack 'chute into the body tube on top of the wadding. Pack the shroud lines and shock cord in on top of the parachute and slip the nose cone into place. Nose cone should separate easily from rocket body tube, but should not be extremely loose. If fit is too tight, sand inside of body tube and shoulder of nose cone with fine sandpaper. If fit is too loose, add a wrapping of masking tape to the shoulder of the nose cone.

**NOTE: DO NOT** pack parachute until you are actually ready to launch. For maximum parachute reliability, lightly dust the 'chute with ordinary talcum powder before each flight, especially in cold weather.

### T-11

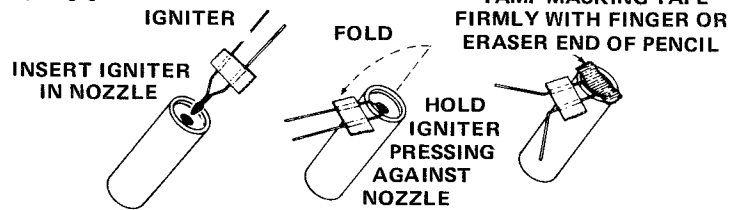

Select an engine and install an igniter as directed in the engine instructions. The engines recommended for use with this rocket are the A8-3, B4-4, B6-4, B8-5, C5-3, and C6-5 made by Estes. Use an A8-3 engine for your first flight.

### T-10

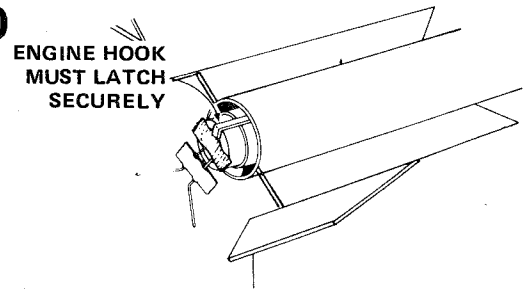

Insert engine into rocket engine mount. Engine hook must latch securely over end of the engine.

### T-9

Disarm the launch panel - REMOVE SAFETY KEY!

### T-8

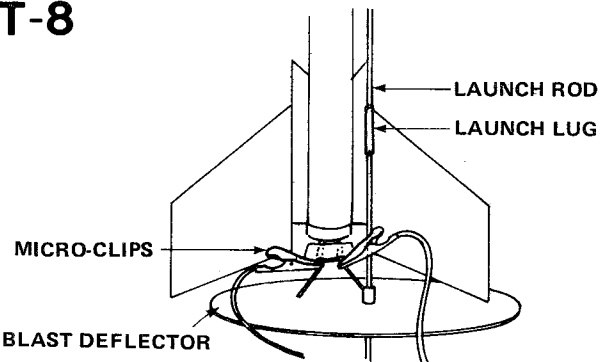

Slide launch rod through rocket launch lug and place rocket on launch pad. Make sure the rocket slides freely on the launch rod. Clean the micro-clips and attach them to the igniter wires. Arrange the clips so they do not touch each other or the metal blast deflector. Attach clips as close to protective tape on igniter as possible.

### T-7

Clear the launch area. Alert recovery crew and trackers. Check for low flying aircraft and unauthorized persons in the recovery area.

### T-6

Arm the launch panel - INSERT SAFETY KEY!

**-5-4-3-2-1-LAUNCH!!**

Repeat Countdown Checklist for each flight.

## MISFIRE PROCEDURE

Disarm the launch panel. Wait one minute before approaching the rocket on the launch pad. Remove the rocket, clean the igniter residue from the nozzle of the engine, and carefully install a new igniter. Repeat the Countdown Checklist.

Failure of the rocket engine to function properly is nearly always caused by a failure to install the igniter correctly. This failure permits the igniter to heat and burn into two pieces without igniting the engine.

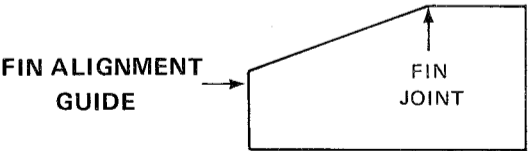
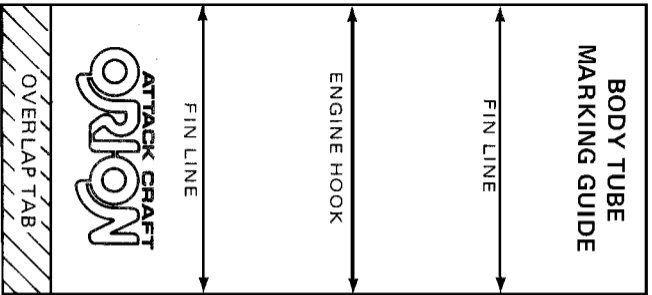

**PN 83379**

Make Two  
(2) of each  
fin out of  
3/32" Balsa

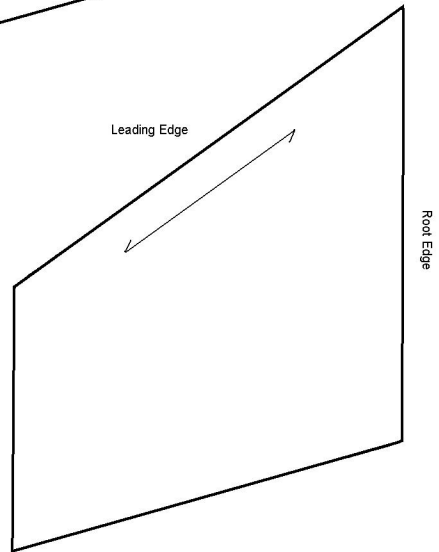
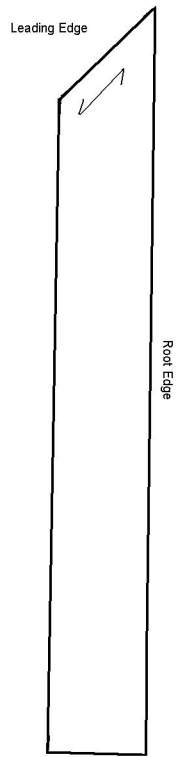
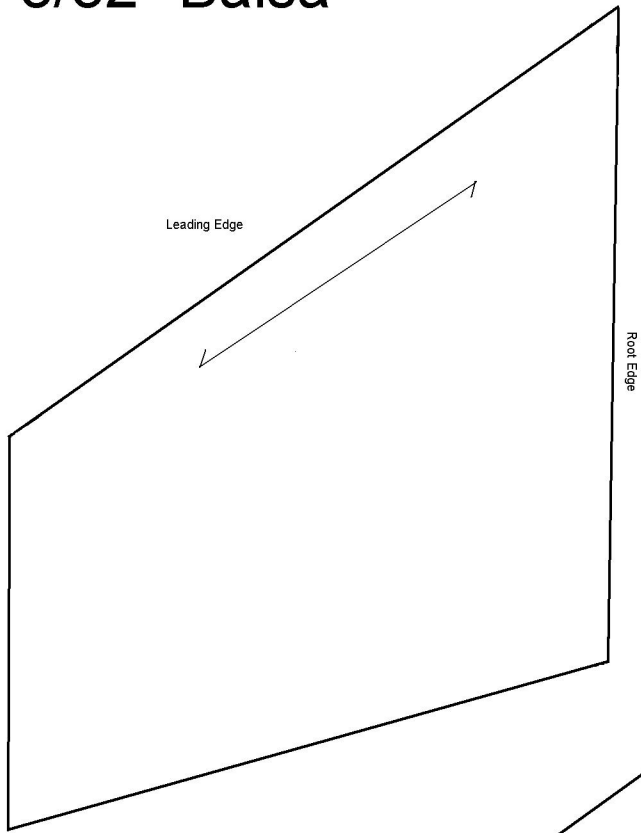

AC ORION

AC ORION

1741

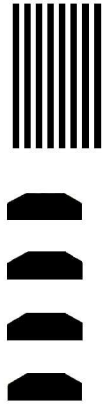

ACO-17

ACO-17

ESTES IND. PN 37515

