

LONGSHOT™

FLYING MODEL ROCKET

SKILL LEVEL 1

Recommended for the Beginning Modeler

■ OVER 3 FEET TALL

- Plastic Nose Cone
- Die-Cut Balsa Fins
- Quick-Release Engine Mount
- 12" Parachute

Length: 40.75 in. (103.5 cm)

Dia: .976 in. (24.8 mm)

Weight: 1.9 oz. (53.7 g)

Recommended Engines:

A8-3, B4-2, B4-4 (First Flight),

B6-4, B8-5, C5-3, C6-3, or C6-5

This is a model kit requiring assembly. Glue and finishing supplies, launch system and engines for flight are not included.

**FLIGHTS
TO
800 FEET!**



A DAMON COMPANY

ESTES INDUSTRIES
REMOSE, CO 81240 USA



#1980



LONGSHOT™

Flying Model Rocket #1980



A DAMON COMPANY

ESTES INDUSTRIES
1295 H STREET
PENROSE, CO 81240 USA



ASSEMBLY TIP

Read all instructions before beginning work on your model. Make sure you have all parts and supplies. Test-fit all parts together before applying any glue. If any parts don't fit properly, sand as required for precision assembly.

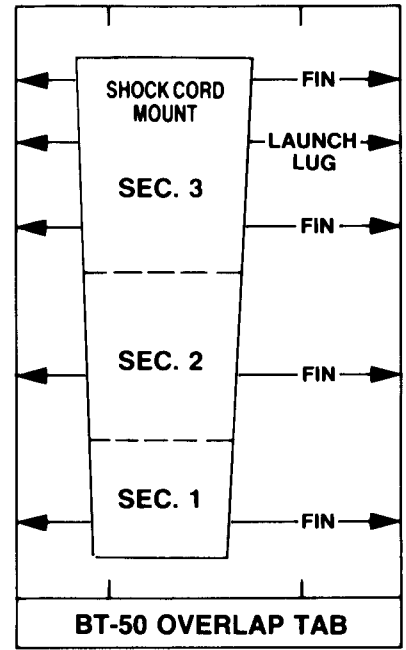

PARTS AND SUPPLIES

Locate the parts shown below and lay them out on the table in front of you. In addition to the parts included in the kit you will also need:

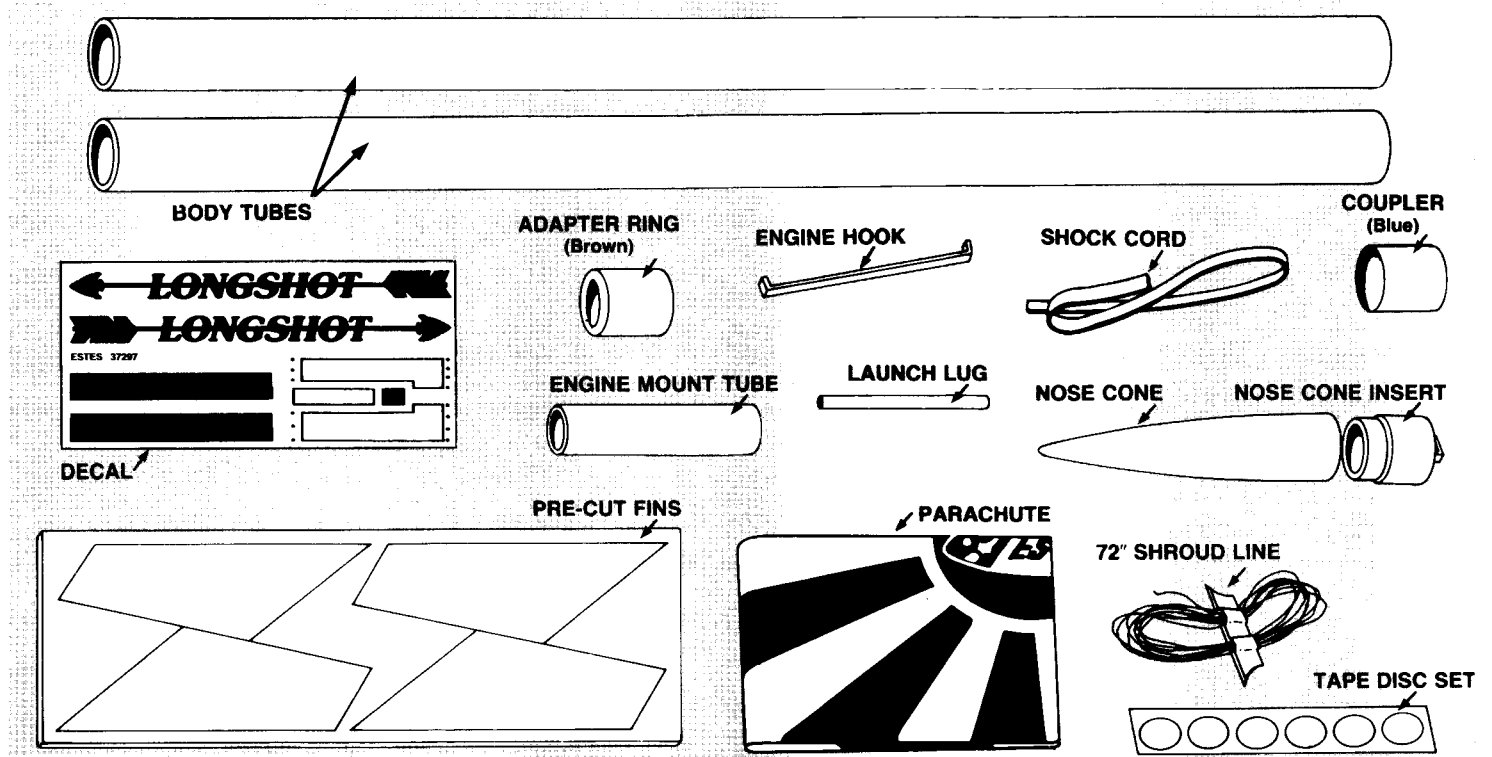
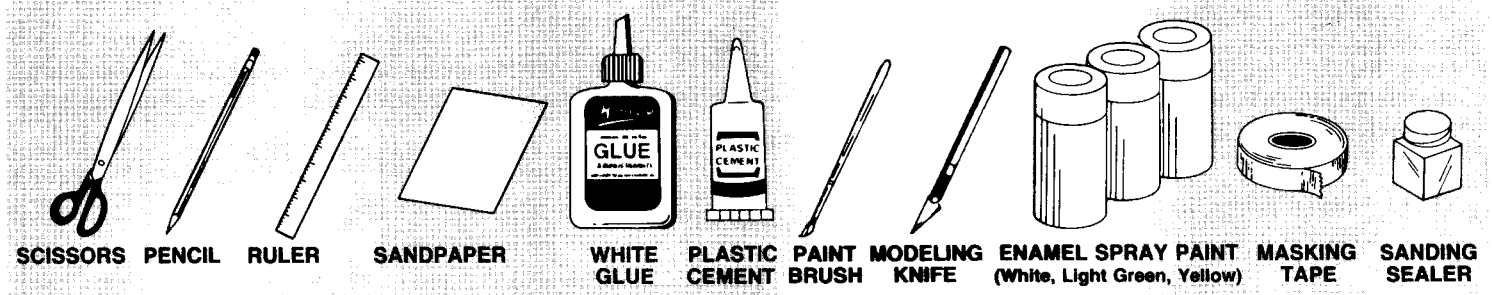

ROCKET ASSEMBLY

1

- Mark engine mount tube 1 inch and 2 1/2 inches from one end and then cut 1/8 inch long slit at 2 1/2 inch mark.
- Insert one end of engine hook into slit.
- Sand inside edges of adapter ring.
- Slide adapter ring onto tube as shown to the 1 inch mark and then glue both ends of ring to tube.

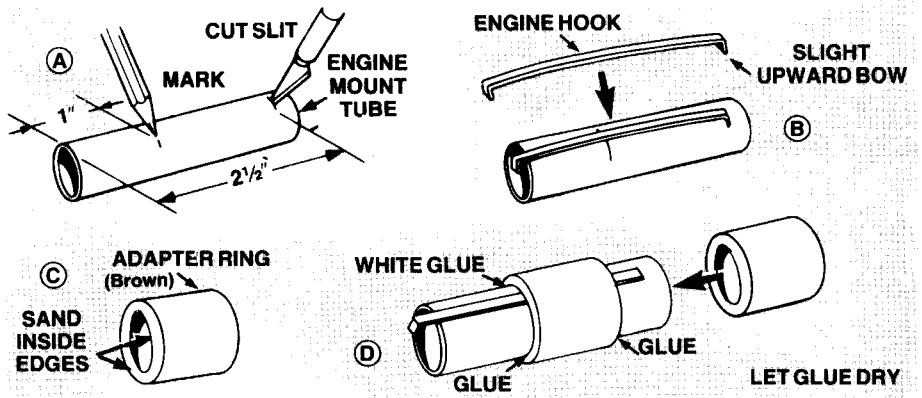

2

- Fine sand balsa die-cut sheet. Carefully remove fins by freeing edges with sharp knife.
- Stack fins together. Sand all edges smooth.

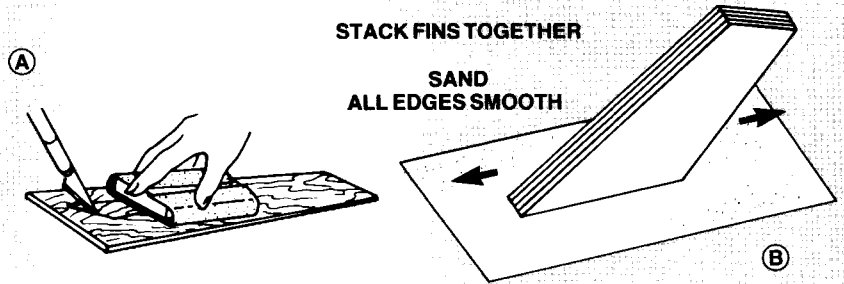

3

- Mark coupler tube 1/2 inch from end.
- Apply glue to inside edge of body tube as shown and insert coupler to 1/2 inch mark. Let glue dry before proceeding.
- Apply glue to one end of remaining body tube and insert exposed coupler into body tube until both body tube ends are touching.
- Place the connected body tubes on smooth, flat surface and roll to make certain body tubes are straight.

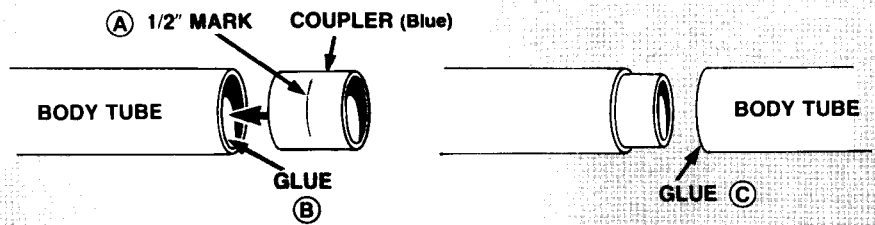

4

- Using a piece of scrap balsa, smear glue inside body tube 1 1/2 inches from one end.
- Push engine mount in until tube ends are even.

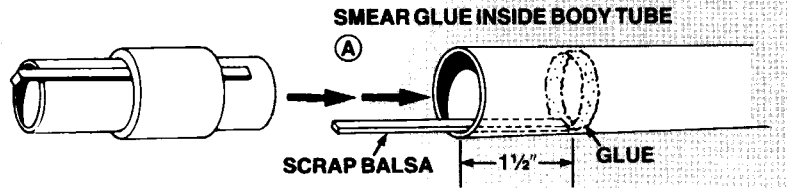

5

- Cut out tube marking guide from front of instructions.
- Wrap guide around the tube and mark tube at arrows. Remove guide and save.
- Draw straight lines connecting each pair of marks.
- Extend launch lug line full length of tube.

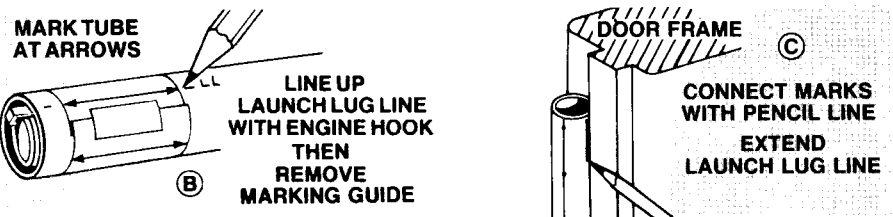

6

- Make a mark on fin alignment lines 1 inch up from end of body tube and then glue fins on alignment lines, one at a time, starting at the 1 inch mark as shown. Let each fin dry several minutes before applying the next fin.
- Looking at the rocket from the rear, the fins should be in the positions shown in illustration marked YES.

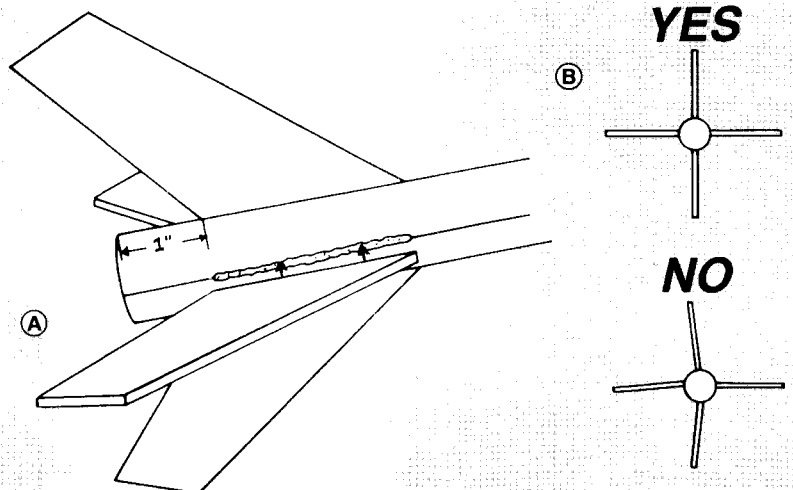

7

- Cut launch lug in half to give two equal pieces $1\frac{3}{16}$ inch in length.
- Glue one lug on launch lug line 13 inches from end of body tube and then glue remaining lug on line 3 inches from end of tube as shown.

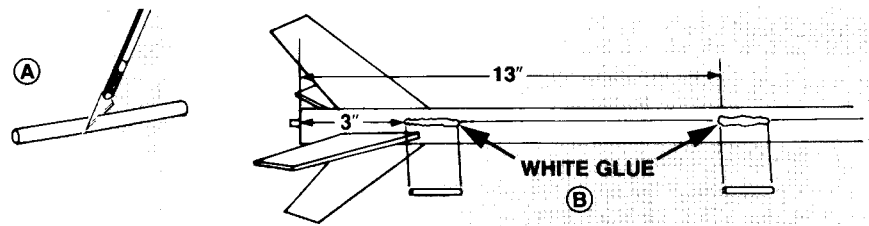

8

- Cut shock cord mount from tube marking guide.
- Crease on dotted lines by folding. Spread glue on section 1 and lay end of shock cord into glue. Fold over and apply glue to back of first section and exposed part of section 2. Lay shock cord as shown with fingers and fold mount over again.
- Clamp unit together with fingers until glue sets.

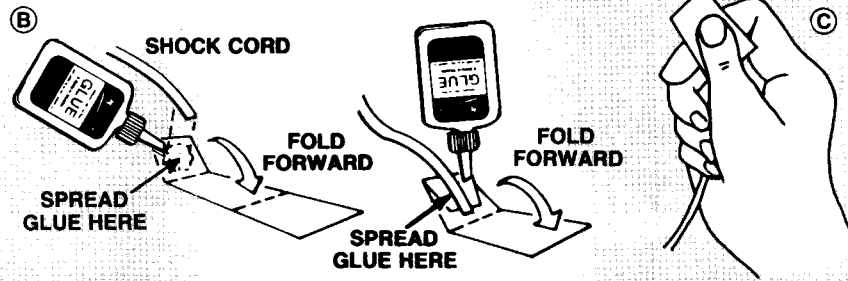

9

- Apply glue inside front of body tube to cover an area no less than 1 inch to 2 inches from end. The glued area should be same size as shock cord mount.
- Press mount firmly into glue as shown.
- Hold until glue sets.

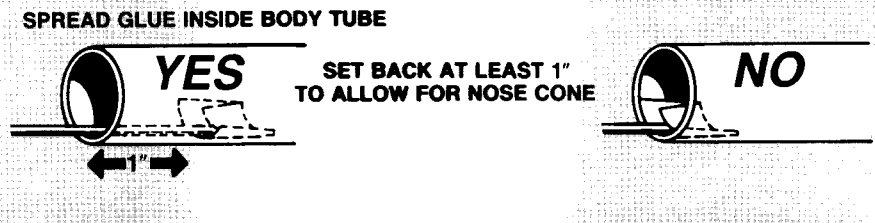

10

- Apply glue reinforcement to each fin/body tube joint and each side of launch lugs.
- Support rocket as shown until glue dries.

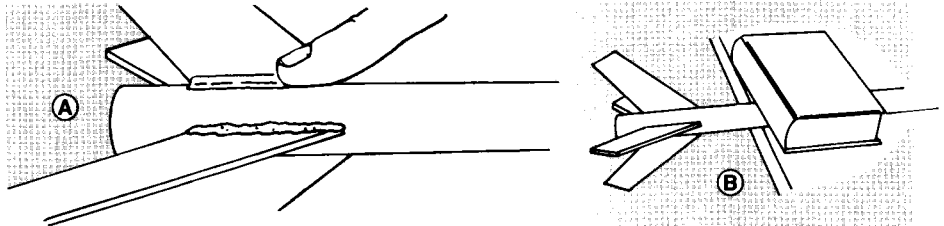

11

- Apply plastic cement to inside edge of nose cone and then insert nose cone insert as shown.

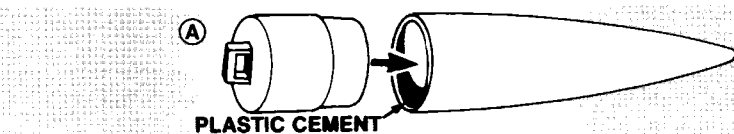

12

- Cut out parachute on edge lines.
- Cut three 23 inch lengths of shroud line.
- Form small loops with shroud line ends and press onto sticky side of tape discs.
- Attach tape discs with line ends to top of parachute as shown.
- Firmly press tape discs into place until both tape discs and parachute material are molded around shroud line loops.
- Pass shroud line loops through eyelet on nose cone. Pass parachute through loop ends and pull lines against the nose cone.
- Tie free end of shock cord to nose cone eyelet.

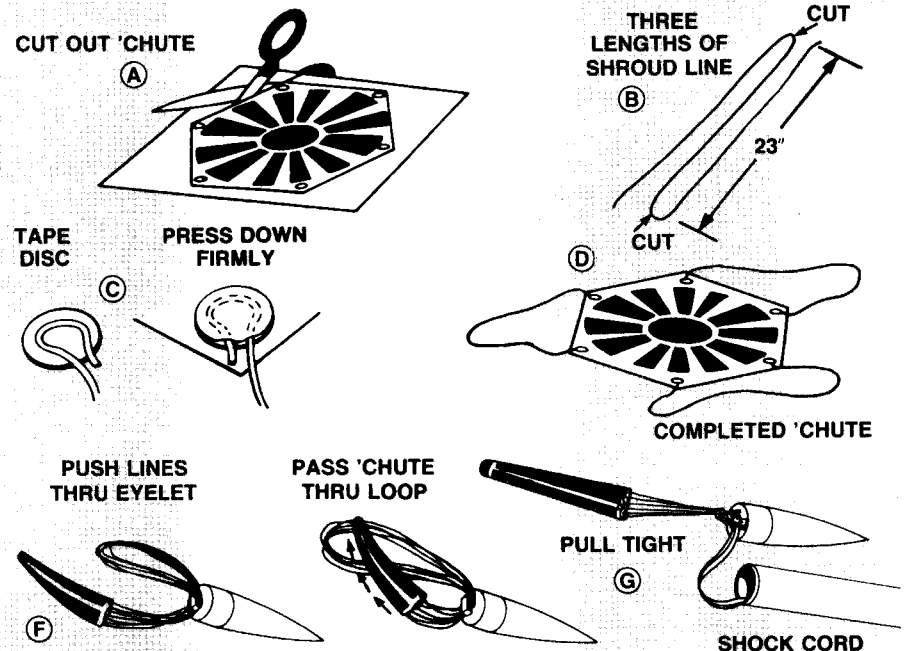

FINISHING YOUR ROCKET

Apply sanding sealer to wood parts with small brush. When sealer is dry, lightly sand all sealed surfaces. Repeat sealing and sanding until balsa grain is filled and smooth. When sanding sealer and glue are completely dry, paint model with spray enamel. Follow instructions on spray can for best results. Let paint dry overnight before masking to paint second color. To apply decals, cut each out, dip in lukewarm

water for 20 seconds, and hold until it uncurls. Refer to photograph on front page and/or on front of panel for decal placement. Slip decal off backing sheet and onto model. Blot away excess water. For best results, let decals dry overnight and apply a coat of clear spray paint to protect decals.

ROCKET PREFLIGHT

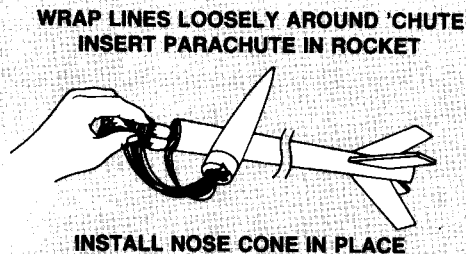
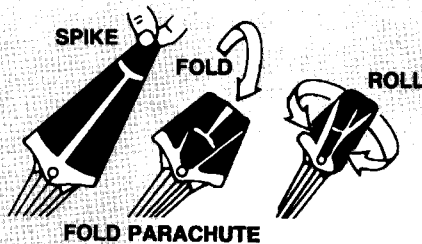
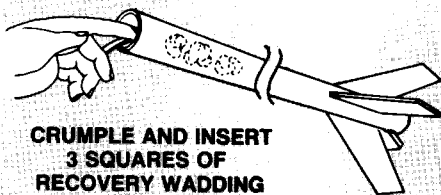

PREPARE ENGINE

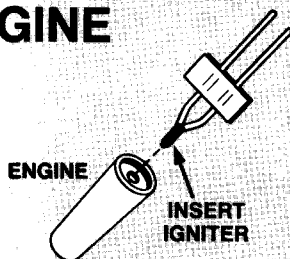
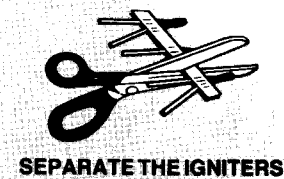

IGNITER TIP MUST TOUCH PROPELLANT DEEP INSIDE NOZZLE OPENING



APPLY AND FIRMLY PRESS TAPE DISC OR MASKING TAPE IN PLACE



HOOK MUST LATCH OVER END OF ENGINE

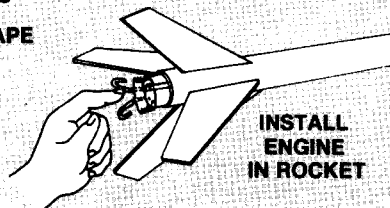

LAUNCH SUPPLIES

To launch your rocket you will need the following items:

- Estes Parachute Recovery Wadding (No. 2274)
- Recommended Engines: A8-3, B4-2, B4-4, B6-4, B8-5, C5-3, C6-3, or C6-5.

To become familiar with your rocket's flight pattern, use a B4-4 engine for your first flight.

FLYING YOUR ROCKET

Choose a large field away from power lines, tall trees, and low flying aircraft. Try to find a field at least 250 feet square. The larger the launch area, the better your chance of recovering your rocket. Football fields and playgrounds are great.

Launch area must be free of dry weeds and brown grass.

Launch only during calm weather with little or no wind and good visibility.

Don't leave parachute packed more than a minute or so before launch during cold weather. [Colder than 40° Fahrenheit (4° Celsius)].

MISFIRES

Failure of the rocket engine to function properly is nearly always caused by a failure to install the igniter correctly. This failure permits the igniter to heat and burn into two pieces without igniting the engine.

FOR YOUR SAFETY AND ENJOYMENT

Always follow the NAR-HIA* MODEL ROCKETRY SAFETY CODE while participating in any model rocketry activities.

*National Association of Rocketry-The Hobby Industry of America

COUNTDOWN AND LAUNCH

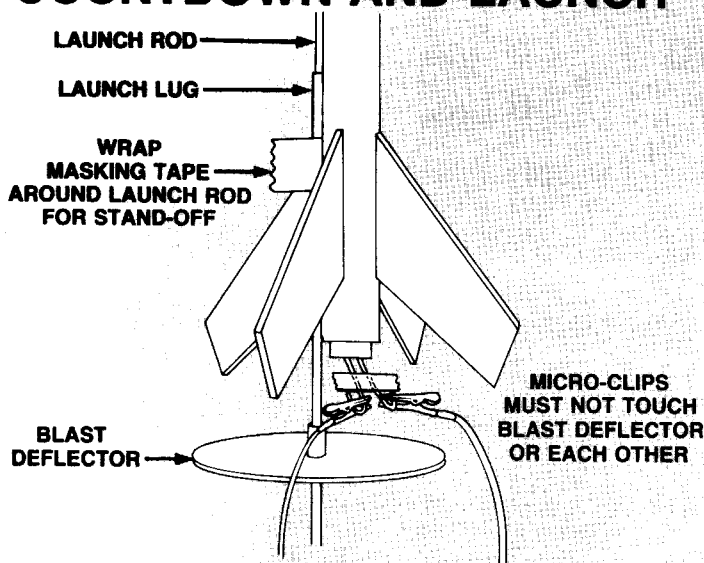

- 5 REMOVE SAFETY KEY to disarm the launch controller.
- 4 Remove safety cap and slide launch lugs over launch rod to place rocket on launch pad. Make sure the rocket slides freely on the launch rod.
- 3 Attach micro-clips to the igniter wires. Arrange the clips so they do not touch each other or the metal blast deflector. Attach clips as close to protective tape on igniter as possible.
- 2 Move back from your rocket as far as launch wire will permit (at least 15 feet).
- 1 INSERT SAFETY KEY to arm the launch controller.

LAUNCH!!! PUSH AND HOLD LAUNCH BUTTON UNTIL ENGINE IGNITES
Remove safety key—Replace cap on rod.

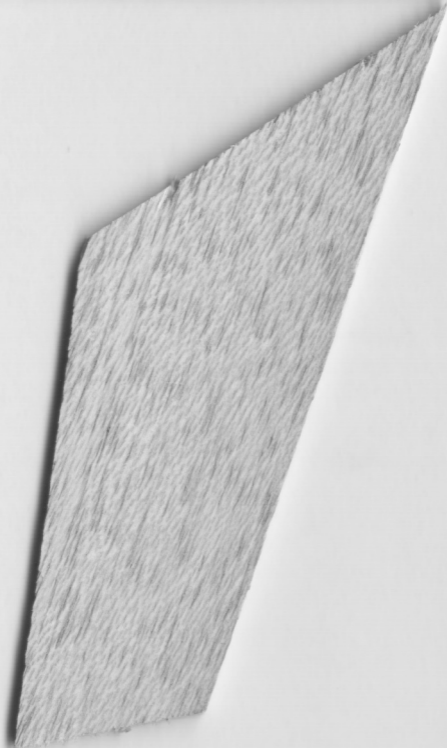



ESTES 37297

