

MODEL

ROCKET

NEWS



IGNITION

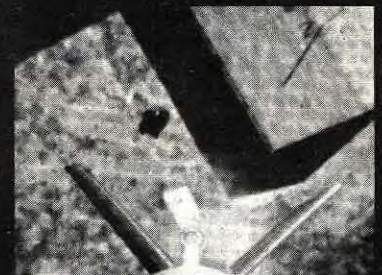

LIFT - OFF



STAGING



COASTING

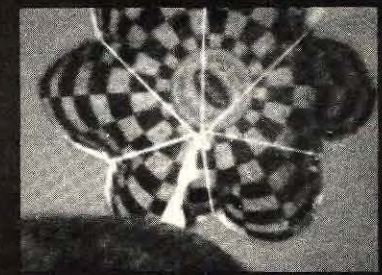

RECOVERY

CINEROC--a new era in model rocketry

(Story, more photos on Page 3)

NOTES FROM THE BOSS



When Apollo 11 lifted off, the whole world was excited. But by the time Apollo 13 was ready to blast off, going to the moon had become so commonplace that the TV networks all but ignored it. As soon as orbit had been achieved, they returned to their regular programs of soap operas, quiz shows, and sports events. Without communications, we "space nuts" could only assume that the mission was progressing on schedule.

Thus, I had given up on TV that eventful evening of April 13 and was down at the office going over some letters from rocketeers. Suddenly the phone rang. "An accident has occurred on the spacecraft," was the message. Rushing home, I found out that, at first, only one network carried the events. Then the others joined in. As we watched through the night and during the next few days, we witnessed an adventure far more exciting than fiction. Perhaps you, too, remember those sleepless days and nights as we lived breathlessly through each event which brought our pioneering heroes home safely.

It sure looked black, didn't it? And I bet that, at first, you didn't believe Jim Lovell, Jack Swigert, and Fred Haise would ever come back. Then things started looking up. And you know why? Because nobody lost his cool.

From the moment Jack Swigert's voice came on, with incredible calm, to announce, "We have a problem here," (What an understatement!) until the safe recovery at sea, no one panicked, no one blew up, no one made a false move. But, more important, no one gave up.

After he had returned safely, Jim Lovell said, "I look back on it as a triumph of teamwork, initiative, and ingenuity, on the ground and in the spacecraft." Well, it's more than that. It also takes a lot of courage to hold up under such terrific pressure and come up with instant solutions that mean the difference between life and death. And while they were mighty short on water, oxygen, and other vital supplies, the Apollo 13 astronauts were unusually long on courage.

Then, there were the men on the ground, working miracles on their computers to save three lives, knowing full well that one small mistake would end the Apollo 13 mission in tragedy. They kept their cool. They "brought 'em back alive."

So, how can anyone call Apollo 13 a failure? Listen to what Jack Swigert had to say, "I didn't come back from this mission with less confidence in

the goals of the space program. I came back with more." That's the way I feel about it. One setback is a small factor compared to our many space achievements.

If there is one thing to be learned from Apollo 13, it is that no matter what the odds are, we Americans stay in there and fight. Jim Lovell said it best after his rescue, "And just by getting back under these critical circumstances, we did prove something about the American capacity for accomplishment under stress: You can do it if you have to do it." That, I feel, is something all of you model rocketeers should always keep in mind. It's the spirit of Apollo 13—the spirit that made us a great nation.

Stop by Cape Estes

"5-4-3-2-1 - Lift off!" That's one of our five tour guides giving the countdown as she prepares to launch a Big Bertha demonstration rocket at Cape Estes. She frequently depends on an Estes rocketeer who just dropped by to help her, and she has never been known to refuse when the visiting V.I.P. (Estes customer) offers to help recover the rocket from out by the Engine Manufacturing Department or across the road in front of the Kit Manufacturing Building. She enjoys her work and would like for you to stop by to see us as you go on your vacation this summer.

The Estes plant is located on U.S. Highway 50 between Pueblo and Canon City (1-1/2 miles east of the junction of Highway 115). We have tours from 8:00 a.m. to 5:00 p.m. every day except Sunday. If your group is larger than 20, we would appreciate a call in advance (at 303-784-6345).

Hope to see you this summer! You are always welcome in Penrose, the Model Rocket Capital of the World.

Vern Estes

A vacation tour guide to aerospace

PLANETARIUMS

- Strasenburgh Planetarium, Rochester, N.Y.
- Hansen Planetarium, Salt Lake City, Utah
- Hayden Planetarium, New York City, N.Y.
- Hayden Planetarium, Boston, Mass.
- Griffith Observatory and Planetarium, L.A., Calif.
- Air Force Academy Planetarium, Colorado Springs, Colo.
- Denver (Colorado) Museum of Natural History (Gates Planetarium)

Adler Planetarium, Chicago, Ill.

Lowell Observatory, Flagstaff, Arizona (It is from this observatory that the planet Pluto was discovered.)

House Morrison Planetarium, San Francisco, Calif.

SPACE EXHIBITS

- Alabama Space and Rocket Center, Huntsville, Alabama
- George C. Marshall Space Flight Center, Huntsville, Alabama

Manned Spacecraft Center, Houston, Texas

Cape Kennedy Visitors Center, Florida

Air Museum of the United States Air Force, Wright Patterson AFB, Dayton, Ohio

The Pacific Science Center, Seattle, Washington

Air Force Academy Visitor's Center, Colorado Springs, Colo.

Neil Armstrong Museum, Wapakoneta, Ohio (under construction)

MUSEUMS

Smithsonian Institution, Washington, D.C.

Portland (Oregon) Museum of Science and Industry

Chicago (Illinois) Museum of Science and Industry

California Academy of Science, San Francisco

Columbus (Ohio) Center of Science and Industry

MODEL ROCKET NEWS

© ESTES INDUSTRIES 1970

The MODEL ROCKET NEWS is published by Estes Industries, Inc., Penrose, Colorado. This publication is written for America's model rocketeers to promote safe youth rocketry, distribute current technical information, and make model rocketry more enjoyable and educational. Current issues of the MRN are distributed free of charge to all active Estes customers.

Vernon Estes-----Publisher
Frank Genty-----Editor
Gene Street-----Chief Illustrator

Meet the "Incredible"

ESTES cineroc

We call it the "incredible" CINE-ROC. And that's just what Estes Industries' latest contribution to the advancement of model rocketry is--by many standards.

Recently introduced on the market, the rugged, all-plastic CINE-ROC is the world's only commercial model rocket movie camera and represents the most important model rocket development in over five years.

What CINE-ROC does, simply stated, is to enable the advanced rocketeer to make moving photographic studies from a vantage point never before possible: The rocket itself. What's more, the Super 8mm movies it takes are in FULL COLOR.

Imagine yourself watching ignition, lift-off, staging, coasting, and parachute deployment from the comfort of your home, either on your Super 8mm projector or on the Estes hand viewer! You see yourself, the launch pad and surrounding terrain become smaller and smaller as the rocket zooms skyward, a view which makes you feel like you were riding up in the rocket. One feature you will like is the semi-slow motion effect obtained with the CINE-ROC's exposure rate of 30 frames per second. And thanks to the single-element 10mm acrylic lens, which takes a sharp image with a great depth of field, you will see the launch lugs and fins of the launch

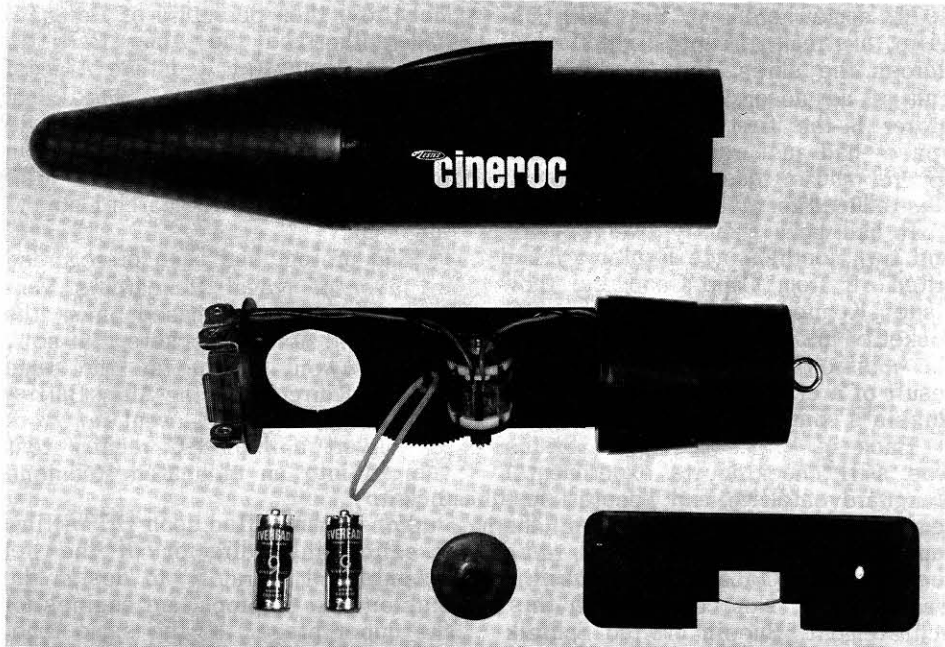

These are the components of the rugged, all-plastic Estes CINE-ROC. At top is the nose cone with the mirror hood, and right below it is the camera proper. The two PFB-2 batteries, drive pulley, and Flight-Pak are at the bottom.

vehicle as clearly as the terrain far below.

Depending on the parachute shroud line arrangement you have selected before the flight, the views you are looking at will give you the realistic feeling of going upward or downward, or making a panoramic sweep of the

horizon. If you use the Estes hand viewer, you'll be able to make a frame-by-frame analysis of your flight, an added advantage in studying acceleration, altitude, rotation, velocity, and burn times.

Fully loaded, including the batteries that power it, the Estes CINE-ROC weighs less than three ounces and can be easily lofted by the Estes ASTRON OMEGA, a "D" engine bird especially designed for the CINE-ROC.

Putting in the film is no problem at all. Just slip in the Flight-Pak film cartridge, and you are ready. Not only does the Flight-Pak eliminate the dangers of ruining film through exposure to light, but it also provides protection for the film before, during, and after the flight. The cartridge contains ten feet of Super 8mm color film, enough for 40 seconds of projection time.

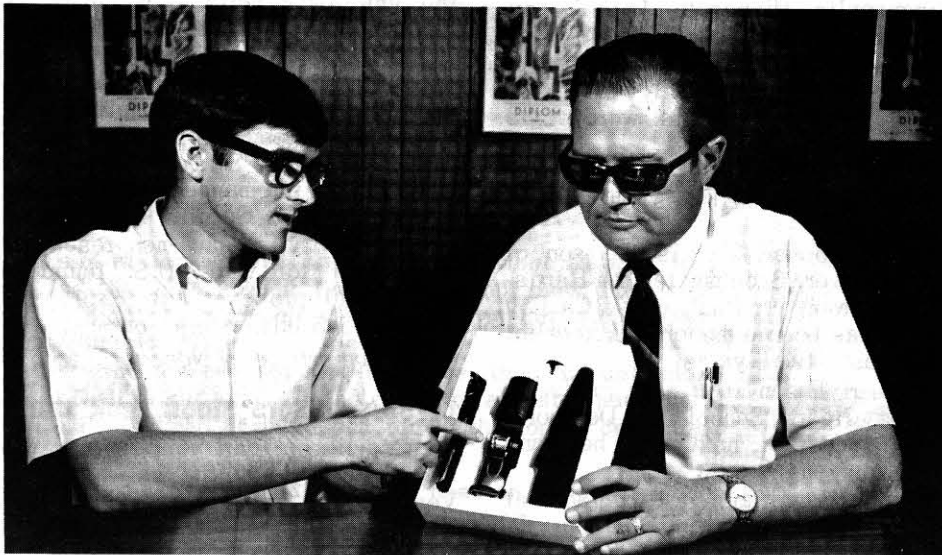

Mike Dorffler (l), a member of the Estes Model Development staff, and Don Beebe, executive director of the Marketing Division, display CINE-ROC package. Originally conceived back in 1965 by Mike, 23, CINE-ROC was developed over the past few years as part of a Research and Development team effort.

CINE-ROC SPECIFICATIONS

10mm focal length lens

f/11— 1/500 sec. shutter

30 frames per second

6" to infinity depth of field

Fiery end for a U.S. "first"

Re-entry marks last of 58,000 Earth revolutions for Explorer I

In the early morning of March 31, 1970, somewhere over the South Pacific, a streak of white light flashed across the skies, thus marking the end of an accomplished dream. Explorer I--the first U.S. satellite in space--had just reentered the atmosphere, and in less than six seconds, was reduced to vapors of metal.

It had been exactly twelve years and two months since Explorer I had lifted off from Cape Canaveral (now Cape Kennedy) atop a Jupiter-C rocket. This was just 84 days after the mission had been ordered, the result of a crash program to overcome Russia's space lead.

Back in 1957, the United States was still checking its experimental Vanguard satellite and booster system, which was sitting on the launching pad, when word was received on October 4 that Sputnik I was in orbit. Not content with this achievement, Russia orbited Sputnik II only 30 days later.

Pressure was now put on the Vanguard team to get their rocket off the pad. On December 6, before a national television audience, Vanguard was launched. It was a disaster. The rocket rose only a few feet, then came back down and blew up.

Paul Hoover wins \$1,000.00 first-place in "Launchstakes"

Paul Hoover, Jr., 12, of Harrisville, West Virginia, has won first place in the 1969 Estes "Launchstakes" and will receive a \$1,000.00 scholarship as his prize. This annual contest was held in December 1969.

Second place awards went to Robert Breen, 16, of Dearborn,

A few weeks before, Neal A. McEllroy, then Secretary of Defense, had authorized the Army Ballistic Missile agency at Redstone Arsenal to revive Project Orbiter. The latter was a plan to use a Redstone missile with an upper stage to orbit an instrumented satellite as a joint effort of the Naval Research Lab and the Army.

The project had been disregarded in favor of Naval Research's Vanguard which was based upon the Viking and Aerobee rockets. But now, Werner von Braun, at the time technical director of the Army Ballistic Missile Agency, went to work to convert a Jupiter-C reentry test vehicle into an elongated Redstone rocket.

Von Braun called upon Dr. William H. Pickering, director of the Jet Propulsion Laboratory to design the cluster of solid-propellant engines for the upper stage. At the same time, Dr. James Van Allen, of the State University of Iowa, provided the major scientific instruments needed.

Renamed Juno I, the Jupiter-C rocket was 68 feet tall, including the 30.8-pound satellite perched on top. It was successfully launched during the night of January 31, 1958, placing

Michigan; Bruce Hagelthorn, 15, also of Dearborn; and Michael Bohn, 16, of Minneapolis, Minnesota. Both Robert and Bruce will receive a \$500.00 scholarship. Michael has elected to take a five-year supply of Estes model rocket materials worth also \$500.00.

There were 50 third-place winners eligible for \$10.00 Estes gift certificates.

Paul Hoover, Jr., is the son of Paul Hoover, Scoutmaster for Harrisville's Troop 80. Paul, himself a Boy Scout, has been a model rocketeer for the past two years.

Robert Breen is a 11th grader at Sacred Heart School in Dearborn. After graduation, next year, he plans to go into engineering.

Bruce Hagelthorn, a 9th grader at Adams Junior High in Dearborn, is not only a model rocketeer, but a fine athlete as well, having lettered in football, swimming and track.

Michael Bohn is an 11th grader and has been a model rocketeer for four years.

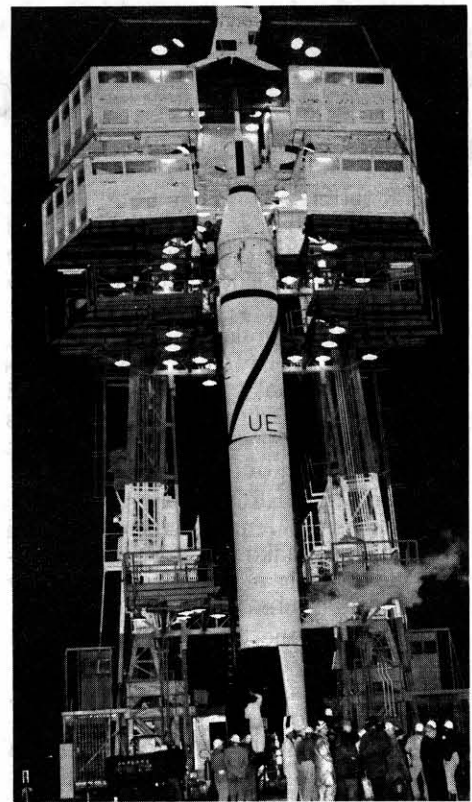

The Jupiter-C rocket that put Explorer I into orbit stands on the pad at what was then Cape Canaveral, just before one of the great moments in space history, on January 31, 1958.

Explorer I into an orbit with an apogee of 1,573 miles and a perigee of 224 miles. The United States was now in "The Space Race."

Soon after attaining orbit, Explorer I transmitted data revealing the existence of the radiation belts that surround the earth. These were named the Van Allen belts in honor of the designer of the instrument package.

During its life, Explorer I made more than 58,000 revolutions of the earth. It was joined by a multitude of other satellites, such as Telstar, Echo, Vanguard, Syncom, and Tiros. It witnessed the manned space flights of Mercury and Gemini. And shortly before reentry, it saw men reach the moon. All told, the U.S. launched nearly 640 probes while Explorer I made its 1.5 billion-mile journey.

(Above article by Norman Avery.)

Estes sponsors moon rock show

We'd like to call your attention to the photograph on the back page of Vern holding a Lunar sample brought back to Earth last July by the Apollo 11 astronauts. This particular sample has an important meaning to Estes Industries, a subsidiary of Damon Corporation, since we sponsored the exhibit with NASA and the National Science Teachers Association.



Hoover

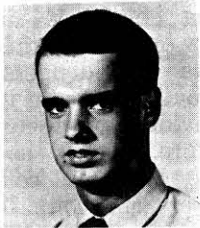

Breen

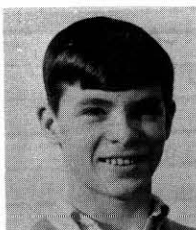

Hagelthorn

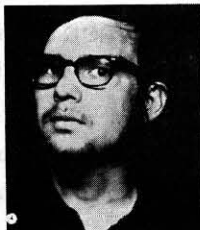

Bohn

THE IDEA BOX



ENGINE CASING MAKES SAFETY CAP

Marc Murphy of Ft. Lauderdale, Fla. sent us this safety cap.

Knock the nozzle out of a used engine casing. Cut a cone shaped piece from a scrap balsa block (NCS-1A or 2A). Apply a ring of glue around balsa cone then wedge cone into engine casing. Fillet cone to inside of casing.

When dry cut and sand cone flush with casing. Paint red, slip over launch rod or 'C' rail.

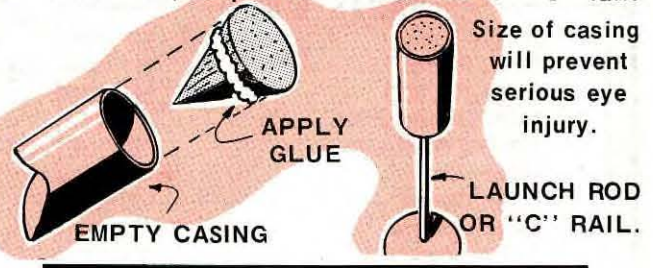

Size of casing will prevent serious eye injury.

NON-SKID RULER

Torrey Sandin of Lincoln, Nebraska, says if you have trouble with ruler slipping while cutting balsa, just glue a couple of pieces of extra-fine sandpaper to the back of your ruler (sand side out).

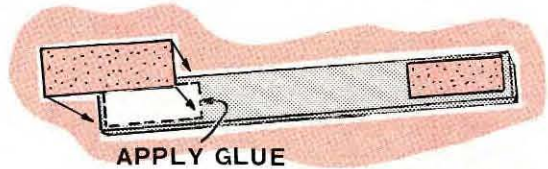

E-Z NOSE CONE SWITCH

Keith Peetz of Arvada, Colo., suggests you cut your shock cord diagonally for easy threading through a snap-swivel eye, then securing it by tape strip or by tying it.

Keith says it is easier to switch nose cones or payload sections using this idea.

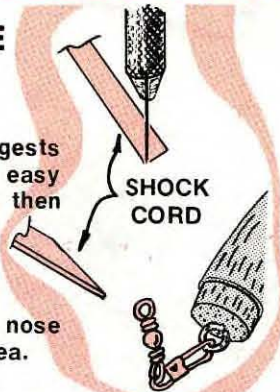

'CHUTE STORING

Kurt Heilbronn of Blue Bell, Pa., suggests putting a snap-swivel on each of the 24' chutes in the Saturn V rocket.

Kurt says while rocket is on display, 'chutes can be stored in an open position (and won't get stuck together).

He says this will keep your parachutes in good condition and can be put on just before launching.

Why not do this to all your rockets?

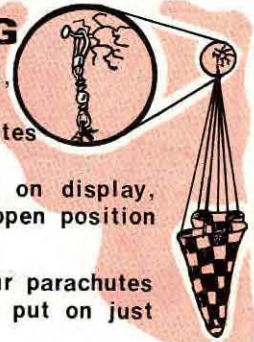

SECURE SHROUD LINES

To prevent shroud lines from pulling out tie a knot 3/4' from end of shroud line. Make a loop at the knot and then attach with a tape strip.

Thanks to Randy Cigel of Stevens Point, Wisconsin.

STOP POWER SHORTING

David Whitney of Los Angeles, Calif., uses an asbestos hot pad (the kind used in homes to set hot pans and irons on) to stop his micro-clips from shorting out against the blast deflector plate.

Cut asbestos hot pad slightly larger than the deflector plate. Drill or cut a hole in the center of asbestos pad, then slip asbestos pad down launch rod to the top of deflector plate.

This idea can be used on the Porta-Pad, Tilt-A-Pad or Electro-Launch.

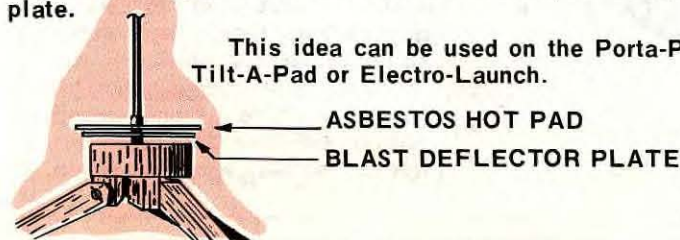

PAINT CORNER



Steve Madas of Woodbury, N. Y., got an interesting starry effect by spraying his model with black, when it dried he sprayed it with a light mist of white from about 2 feet away.



Douglas Springer of Lakeside, Mich., cleaned out fingernail polish bottles, poured paint into them and used the small brush to do touch-up and detail work.

Estes Industries Rocket Plan No. 71 BLACK KNIGHT

JAN. '70

DESIGN OF THE MONTH WINNER

by Joseph Aitken, APO San Francisco, Calif.

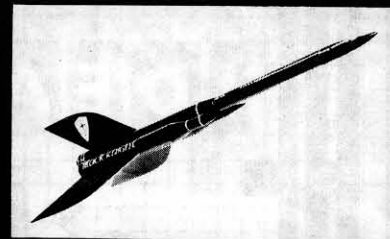

PUBLISHED AS A SERVICE TO ITS CUSTOMERS BY ESTES INDUSTRIES, INC., BOX 227, PENROSE, CO. 81240

© ESTES INDUSTRIES 1970

PARTS LIST

- | | | |
|---|-------------------|----------|
| 1 | Body Tube | BT-50W |
| 2 | Body Tubes | BT-50H |
| 1 | Body Tube | BT-20D |
| 1 | Body Tube | BT-20J |
| 1 | Body Tube | BT-5P |
| 1 | Nose Cone | BNC-20N |
| 2 | Nose Cones | BNC-5S |
| 1 | Tube Adapter | TA-2050A |
| 2 | Tube Adapters | TA-550 |
| 2 | Nose Blocks | NB-50 |
| 3 | Fin Stock | BFS-20 |
| 1 | Engine Holder | EH-2 |
| 5 | Centering Rings | RA-2050 |
| 2 | Parachute Kits | PK-8 |
| 2 | Screw Eyes | SE-3 |
| 2 | Shock Cords | SC-1 |
| 2 | Snap Swivels | SV-12 |
| 1 | Launching Lug | LL-2B |
| 3 | Nose Cone Weights | NCW-2 |
| 1 | Fin Pattern Sheet | FP-171 |

(Fin pattern will be sent free with order if requested, or send a stamped self-addressed envelope.)

You will also need a model knife, glue sandpaper, a brush and paint.

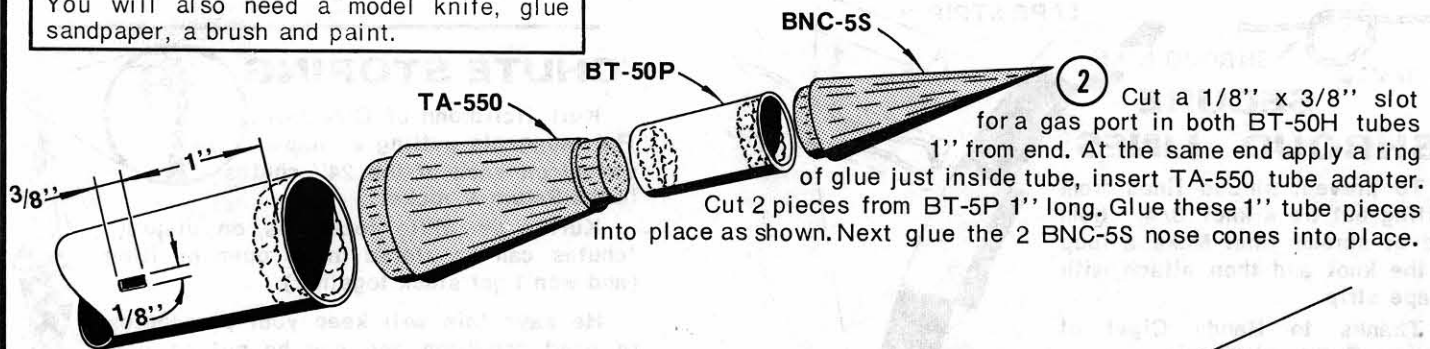
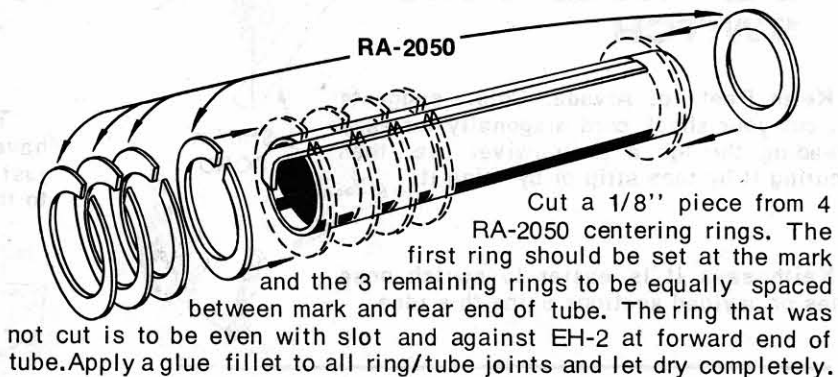
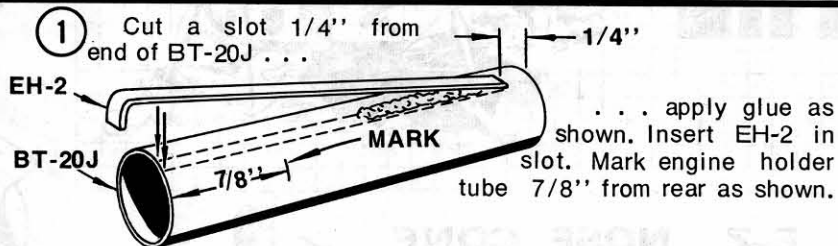

Mark the BT-50H tubes for fin alignment. Guide line should be exactly straight across from gas port as shown.

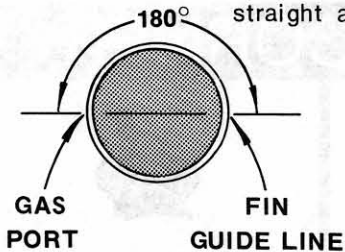

ENGINE HOLDER ASSEMBLY

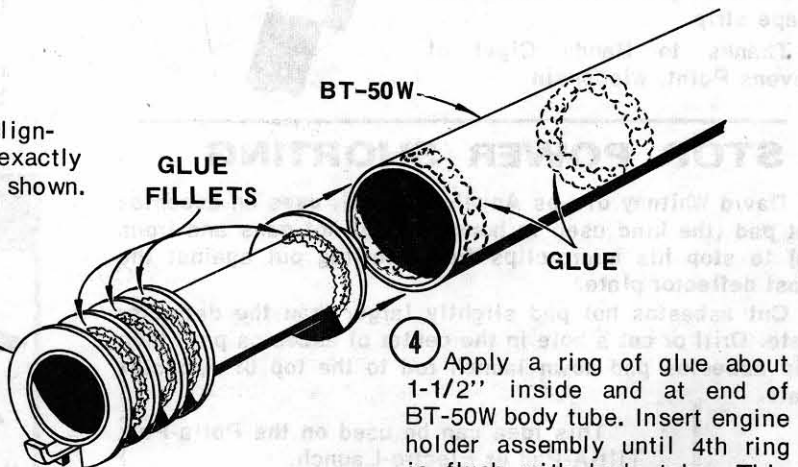

3 Copy fin pattern from pattern sheet onto BFS-20 observing grain direction. Cut fins out and sand all leading and trailing edges round,

4 Apply a ring of glue about 1-1/2" inside and at end of BT-50W body tube. Insert engine holder assembly until 4th ring is flush with body tube. This should be done in one smooth motion or the assembly may freeze in the wrong position.

5 Mark the BT-50W body tube at 120° for 1/8" x 3/8" gas ports and rudder. Gas ports to be 2-11/16" from front of tube.

Use the marking guide in the Technical Section of your ESTES catalog.

6 Glue tube adapter TA-2050 and body tube BT-20D into place as shown. Do not glue nose cone BNC-20N if payload is desired.

7 Attach both BT-50H tubes to the BT-50W body tube. Be sure gas ports are lined up exactly. Apply a good glue fillet to both tube joints.

8 Attach fins as shown. Launch lug should be centered on bottom of BT-50W and antennas should be centered, one on each side of BT-50W as shown.

9 Attach recovery system and shock cords to the nose blocks as shown. Use standard shock cord anchor.

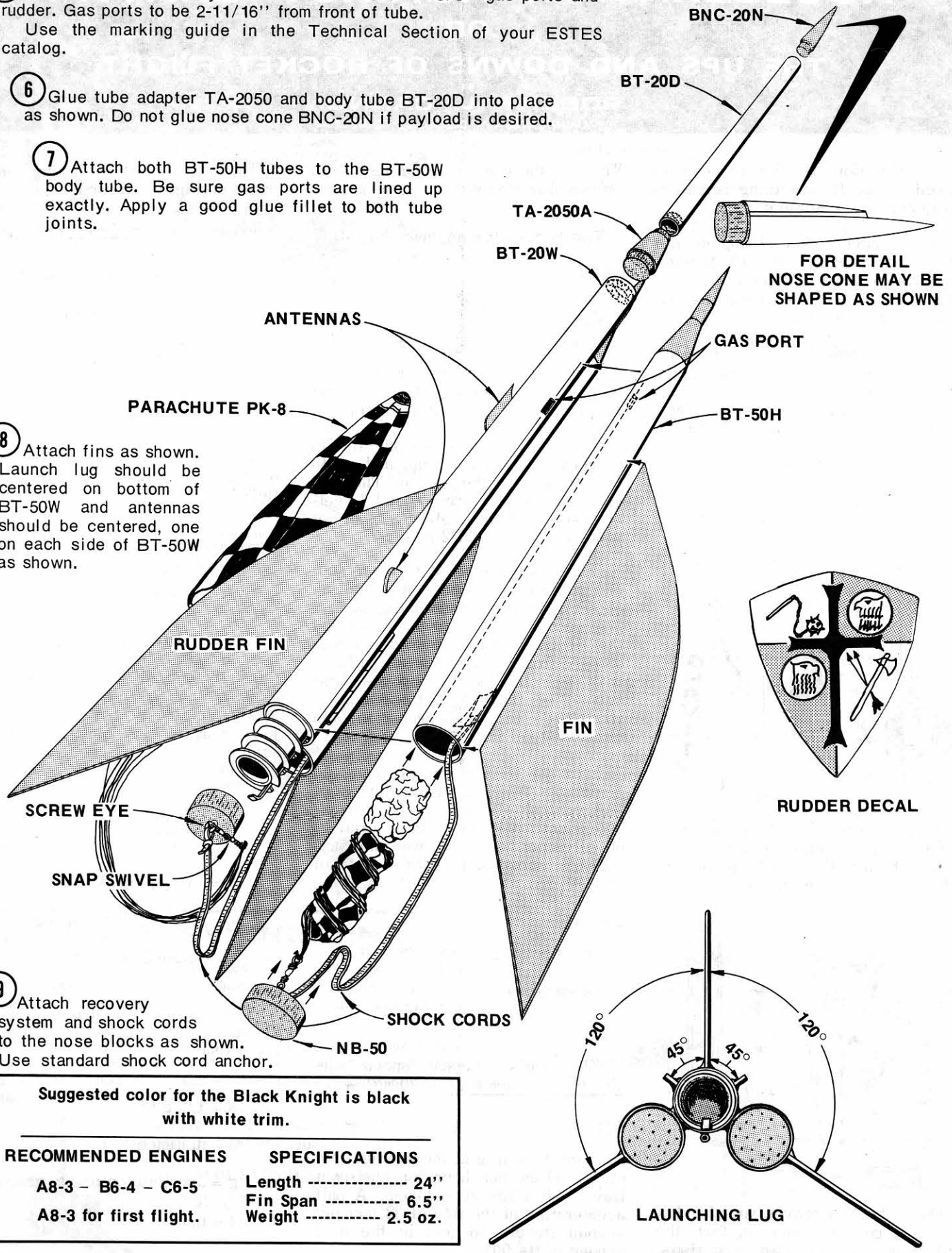

Suggested color for the Black Knight is black with white trim.

RECOMMENDED ENGINES	SPECIFICATIONS
A8-3 - B6-4 - C6-5	Length ----- 24"
A8-3 for first flight.	Fin Span ----- 6.5"
	Weight ----- 2.5 oz.

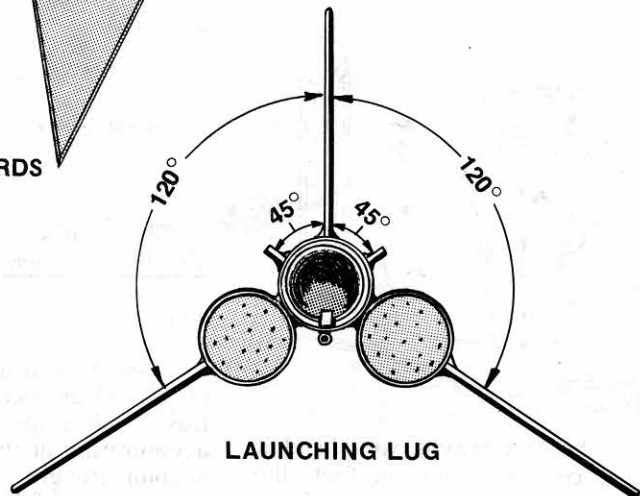

ACCELERATION AGAINST GRAVITY

OR

THE UPS AND DOWNS OF ROCKET FLIGHT

BY
ROBERT L. CANNON
 COMMUNICATIONS DIVISION DIRECTOR

Acceleration is the process of speeding up. If something begins to go faster, it accelerates.

Your model rocket sitting on the launch pad is not accelerating. When it starts to move, it accelerates. As long as its speed is increasing, the rocket is accelerating.

To be technical, an object which is gaining speed is undergoing positive acceleration. A moving body which is slowing down is undergoing negative acceleration. Negative acceleration is sometimes called deceleration.

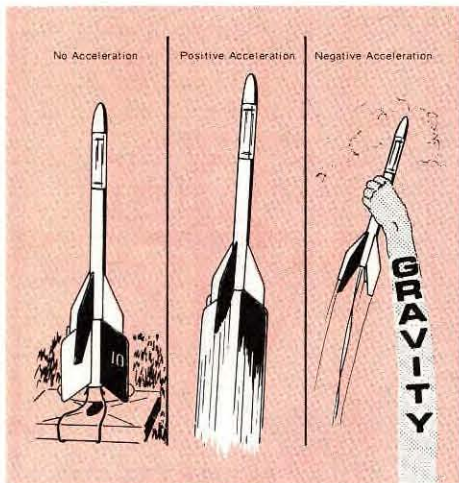

A good example of acceleration occurs when you throw a ball straight up into the air. The ball is going very fast as it leaves your hand.

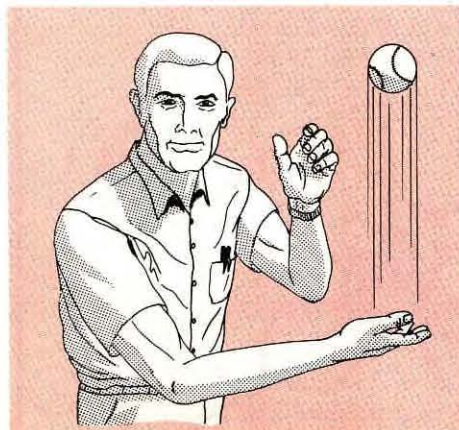

Once the ball leaves your hand it does not go any faster, in fact, the ball starts slowing down as it rises.

What are the two forces acting on the ball to slow it down?

Two forces slowing down the ball:

- 1.
- 2.

The two forces are gravity, and drag (friction between the ball and the air through which it is traveling).

The ball soon loses all of its momentum, stops going up, and starts to fall back to the ground. The rate at which the ball gains speed (accelerates) as it falls is about 32 feet per second per second (32 ft/sec²).

This expression--32 feet per second per second--means that a falling object near the ground falls 32 feet per second faster for each second that it falls. In other words, a ball dropped from the top of a tall building will fall 16 feet during its first second of fall. Does this surprise you? Let's take an example to help us understand this.

If a car travels for one hour and begins its trip from a standing start and very slowly and steadily accelerates until it is traveling at a rate of 60 miles per hour, what was the car's average speed during this hour of travel?

Average speed = $\frac{\text{final speed} - \text{original speed}}{2}$

Average speed =

The car's average speed was $\frac{60 - 0 \text{ miles per hour}}{2}$ or 30 miles per hour.

A car traveling at the average rate of 30 miles per hour for one hour travels 30 miles in that hour. A ball accelerating at the rate of 32 feet per second travels 16 feet in the first second of its fall.

How far does a falling object travel during two seconds?

Average speed = $\frac{\text{final speed} - \text{original speed}}{2}$

= $\frac{64 \text{ feet per second} - 0}{2}$

= 32 feet per second

Distance traveled = average speed x time in motion

= 32 feet per second x 2 seconds

= 64 feet

How far did the falling ball travel during the second one-second of its fall?

Distance traveled in the second second = total distance traveled - distance traveled in first second

= 64 feet - 16 feet

= 48 feet

To simplify calculations we can use formulas instead of having to think through all of the steps in a problem each time we need to solve another problem of the same type. For example, the formula for determining the average speed of a falling body is--

$\bar{v} = \frac{v_2 - v_1}{2}$

\bar{v} = average velocity

v_2 = final velocity (speed)

v_1 = original velocity

The formula for determining the distance an object falls during a given time is--

$s = 1/2 g t^2$

s = distance

g = acceleration due to gravity

t = time

How far does a falling body travel during the third second of its fall?

$$\begin{aligned}
 s &= 1/2 gt^2 \\
 s &= 1/2 \times 32 \text{ feet/second}^2 \times (3 \text{ seconds})^2 \\
 &= 1/2 \times 32 \text{ feet/second}^2 \times 9 \text{ seconds}^2 \\
 &= 1/2 \times 32 \text{ feet} \times 9 \\
 &= 16 \times 9 \text{ feet} \\
 &= 144 \text{ feet}
 \end{aligned}$$

The ball falls 144 feet in three seconds. Since the ball fell 64 feet in two seconds, the ball falls 80 feet during the third second of its fall (144 feet minus 64 feet).

A falling object keeps accelerating because of the force of gravity acting on it until the friction of the air moving past the falling body prevents the object from falling any faster. When this maximum speed is reached the object ceases to accelerate and falls at its terminal velocity.

LET'S TRY A PROBLEM

Using the following formulas (Some are simplified to avoid using higher mathematics.) we can determine some values for accelerations and velocities for model rockets. The values given are based on theoretical "no drag" conditions.

$$v_2 = \left(\frac{F}{w_{av}} - 1 \right) gt$$

w_{av} = average weight of rocket

F = force (average thrust of rocket engine)

g = acceleration due to gravity (32 ft./sec.²)

ALPHA FLIGHT ANALYSIS

Using the above formula for velocity, determine the burnout velocity of an Alpha launched using an A8-3 engine. The Alpha weighs 0.8 ounces without engine. With an A8-3 engine the Alpha weighs 1.37 ounces at lift-off. The weight of propellant in an A8-3 engine is 0.11 ounces giving an average weight of 1.32 ounces during the thrust phase of the flight. The A8-3 engine thrusts for 0.32 seconds and has a total impulse of 0.56 pound-seconds. (These values may be found in or calculated from information in the current Estes catalog.)

First find the average force, then use this force in the velocity formula to find the final velocity.

$$\text{Force (thrust)} = \frac{\text{total impulse}}{\text{burn time}} \times \frac{16 \text{ oz.}}{1 \text{ lb.}} \} \text{conversion factor}$$

A graph can present a lot of information quickly. Studying a graph can sometimes help you to understand something that may be hard to understand otherwise.

Let us examine the graph for the distances a falling body travels during the first few seconds of its fall. This graph represents the distance a body falls under the constant acceleration of gravity (neglecting air friction).

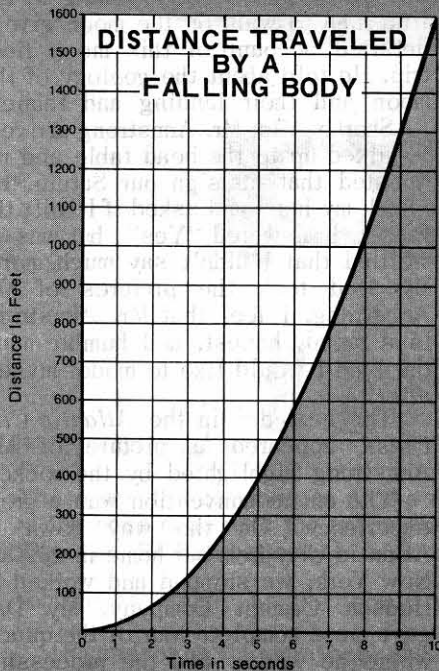

GRAPHS

To help understand the velocities which falling objects can develop, (neglecting air friction) examine a graph of the velocities developed by freely falling objects. These graphs are based on results obtained by use of these formulas--

$$v_2 = at$$

$$s = v_1 t + \frac{at^2}{2}$$

a = acceleration

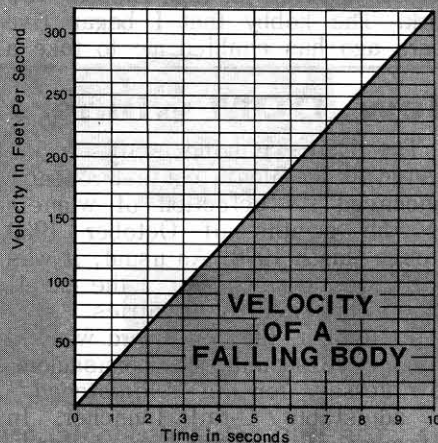

To find the actual velocities which your birds will attain when allowance for air drag is made, use the 1970 edition of TR-10 (Cat. #702-TR-10-\$1.00).

$$\begin{aligned}
 F &= \frac{0.56 \text{ lb.-sec.}}{0.32 \text{ sec.}} \times \frac{16 \text{ oz.}}{1 \text{ lb.}} \\
 &= 1.75 \times 16 \text{ oz.} \\
 &= 28.0 \text{ oz.}
 \end{aligned}$$

$$\begin{aligned}
 v_2 &= \left(\frac{F}{w_{av}} - 1 \right) gt \\
 v_2 &= \left(\frac{28.0 \text{ oz.}}{1.32 \text{ oz.}} - 1 \right) (32 \text{ ft./sec.}^2) (0.32 \text{ sec.}) \\
 &= (21.21 - 1) (32 \text{ ft./sec.}^2) (0.32 \text{ sec.}) \\
 &= (20.21) (10.24 \text{ ft./sec.}) \\
 &= 206.95 \text{ ft./sec.}
 \end{aligned}$$

The expression $\left(\frac{F}{w_{av}} - 1 \right)$ gives you an idea of the number of "gravities" the rocket experiences in upward flight during acceleration. The "1" is subtracted in this expression to allow for the pull of Earth's gravity on the rocket. This rocket develops a fairly high velocity by the end of the thrusting phase of the flight.

What will be the velocity developed by the same Alpha launched with a C6-5 engine?

$$F = \frac{2.25 \text{ lb./sec.}}{1.70 \text{ sec.}} \times \frac{16 \text{ oz.}}{1 \text{ lb.}}$$

$$\begin{aligned}
 v_2 &= \left(\frac{\text{Force}}{1.49 \text{ oz.}} - 1 \right) (32 \text{ ft./sec.}^2) (1.7 \text{ sec.}) \\
 &= \\
 &= \\
 &= \text{ft./sec.}
 \end{aligned}$$

This velocity (716.45 feet per second) developed by the Alpha with the C6-5 engine is more than triple the velocity (206.95 feet per second) which was developed by the A8-3 engine. Notice that the thrust and therefore the acceleration in "g"s produced by the C6-5 engine (13.17 g) is less than that produced by the A8-3 engine (20.21 g), but the maximum velocity is greater when using the C6-5 engine because the burn time for this engine is greater.

I wonder what the acceleration would be in "g"s for the Goblin with a D13-7 engine? Hmm. . .

First man on Moon autographs Scott Cutcliffe's Saturn 1-B

Estes rocketeer almost speechless as he meets Neil Armstrong

How does it feel to meet the first man who ever walked on the moon-- and shake hands with him? For 13-year-old Scott Cutcliffe, an Estes model rocketeer, it was quite an experience. And so much so that he was practically speechless when Neil Armstrong spoke to him. Here, in an exclusive article for Model Rocket News, Scott tells it like it was.

They say that model rocketry can be educational. It sure has been for me, Scott Cutcliffe, from Elnora, New York. The hobby that I began five years ago has enabled me to take a

New DOM winners

The Estes judging staff for the Design of the Month contest recently announced its selection of winners for the months of October 1969 through March 1970. As usual, it was a difficult task because of the excellence of the majority of entries.

In October, the \$50 award went to Anthony Altadonna, of Pennsauken, New Jersey, for his "Adjustapad," an adjustable C-rail launcher. In November, it was the turn of Randy Gibson, of Cottondale, Alabama, for his *Constrictor*, a bird featuring a non-symmetrical fin layout and external shock cord mounting (see MODEL ROCKET NEWS, Volume 10, No. 1, February 1970). The December winner was George Semples, of Winchester, Virginia, who had submitted a thrust-measuring stand using a spring scale.

Joseph Aitken, a member of the Armed Forces, took top honors in January with his *Black Knight*, a futuristic transport. He was followed in February by Stephen Price, of Albuquerque, New Mexico, whose winning entry was a *Planetary Transport*. In March, the judges selected Jerry Wyant, of Charlottesville, Virginia, for his annular wing boost glider, christened *Chrysophylax*.

All Estes rocketeers are encouraged to enter the Design of the Month contest. Plans for rockets, launchers, instruments, etc., may be submitted. A new contest begins on the first of each month so that entries compete only with other entries received in that month.

Any plan or design received by Estes Industries that is not specifically addressed to some other contest or department is automatically entered in the Design of the Month contest. Complete information on the contest appears on Page 135 of your current Estes catalog.

three-day trip to Atlantic City, New Jersey. There I attended the National Geological Society of America Convention with my father. There, I met, and shook hands with Neil Armstrong.

What excitement to sit at a banquet attended by 1,700 geologists from all over the world! Our rocket, the Estes Saturn 1-B, was used as a centerpiece. There, I sat with my Dad, a consulting geologist, listening to the first man to walk on the moon give a detailed account of this moon field trip. He told about the geology of the moon and their landing and launch.

Shortly after Mr. Armstrong arrived, I walked up to the head table and requested that he sign our Saturn. He shook my hand and asked if I built the rocket. I answered "Yes", but was so thrilled that I didn't say much more. My Dad took the pictures of Mr. Armstrong. I feel that Mr. Armstrong is a proud, honest, and humble man, the kind I would like to model myself after.

The next day in the *Atlantic City Press* appeared a picture of Mr. Armstrong highlighted by the rocket.

The entire convention was a great experience. On the way down to Atlantic City from our home in upstate New York, we stopped and worked at Hudson Cement Company. My Dad gave me a complete tour of the quarry where he works and the processing plant.

I attended a paper or two with my father, but spent nearly all of my time at scientific films presented by the New Jersey Geological Survey.

My brothers, Steven, 10, and David, 9, are both Estes rocketeers. My cousin, Larry Ellis, originally developed my interest in rocketry. We started small with the Sprite and a battery pack launch system. We now have built about 12 rockets and a car battery launch system.

I am 13 years old and attend Shenendehowa Junior High School. I am in the Yorker Club, which is a service-oriented organization that meets in my Junior High School. I am also in Boy Scouts. I'm a First Class Scout and have been in Scouting for two years. We have a spring and fall camp and in the summer we can either go on a week's hike with my troop or go to summer camp.

My mother is a Registered Nurse and comes along with the whole family for most of the launches. We successfully launch our Big Bertha and Gemini rockets.

I look forward to new experiences



Scott Cutcliffe displays his Estes Saturn 1-B with Armstrong's signature.



Neil Armstrong looks at Estes Saturn 1-B used as centerpiece for National Geological Society of America meet.

in the future that will develop from my rocketry. I don't know what they will be, but it's taken me a long way already. Maybe into space itself.

Estes to sponsor team member for world meet in Yugoslavia

Estes Industries will sponsor one member of the team that will represent the United States at the First World Championship in Vrsac, Yugoslavia, this September. The announcement was made by Estes' President Vernon Estes who, with his wife, Gleda, and possibly their three daughters, will attend the meeting.

The \$500.00 that will be contributed by Estes Industries will provide one of the contestants with air transportation from the U.S. to Yugoslavia and return, entry fees, and food and lodging.

The Rocket Eating Tree--It has a big appetite

At one time or another, model rocketeers may have tangled up with this voracious creature: The Rocket Eating Tree. Peter Chodakowski, an Estes rocketeer from Mason, Michigan, recently had his first encounter with the beast. It prompted him to write the following observations for MODEL ROCKET NEWS.

The *Rocketus eatumupus* (direct descendant of the *Kitetus eatumupus*) commonly called the Rocket Eating Tree, can be found near any place suitable to launch a rocket. Sometimes it is the only thing within a large radius of the place where a person launches his rocket.

The *Rocketus eatumupus* variety of tree should not be taken lightly. Even though it is the only tree within 500 yards, the Rocket Eating Tree reaches out to grab any passing rocket with the help of its ally, the wind, which likes to surprise rocketeers by not blowing until the parachute is out.

The *Rocketus eatumupi* have a very gourmet type of appetite. They usually feed on such rockets as the Trident, the Orbital Transport, Big Bertha, the Arcas and other such rockets which are considered delicacies. The Rocket Eating Tree sometimes lets the smaller rockets go by so that the rocketeer launching the rocket might get up enough confidence to launch a bigger one.

The Rocket Eating Tree gives no warning before it grabs a rocket. You cannot tell it from an ordinary tree, so the next time you launch a rocket... BEWARE!!!!

Ed Brown will go to Portales for ESTES

Ed Brown, a member of the Research and Development staff at Estes Industries, Penrose, Colorado, will be the Estes representative at the Southwestern Model Rocket Conference. The conference will be held July 23-24-25 on the campus of Eastern New Mexico University and is sponsored by the ARC-Polaris Rocket Club of Portales, New Mexico.

The club plans to bring in four displays recently released by the Manned Spacecraft Center. An MSC Spacemobile display might be available in time for the Conference.

Events scheduled at this time include: Twelve areas of competition with computerized scoring; a math, physics, and computer seminar using an IBM 360 model 40K computer; and talks by experimenters working on the recent OGO and OSO satellites.

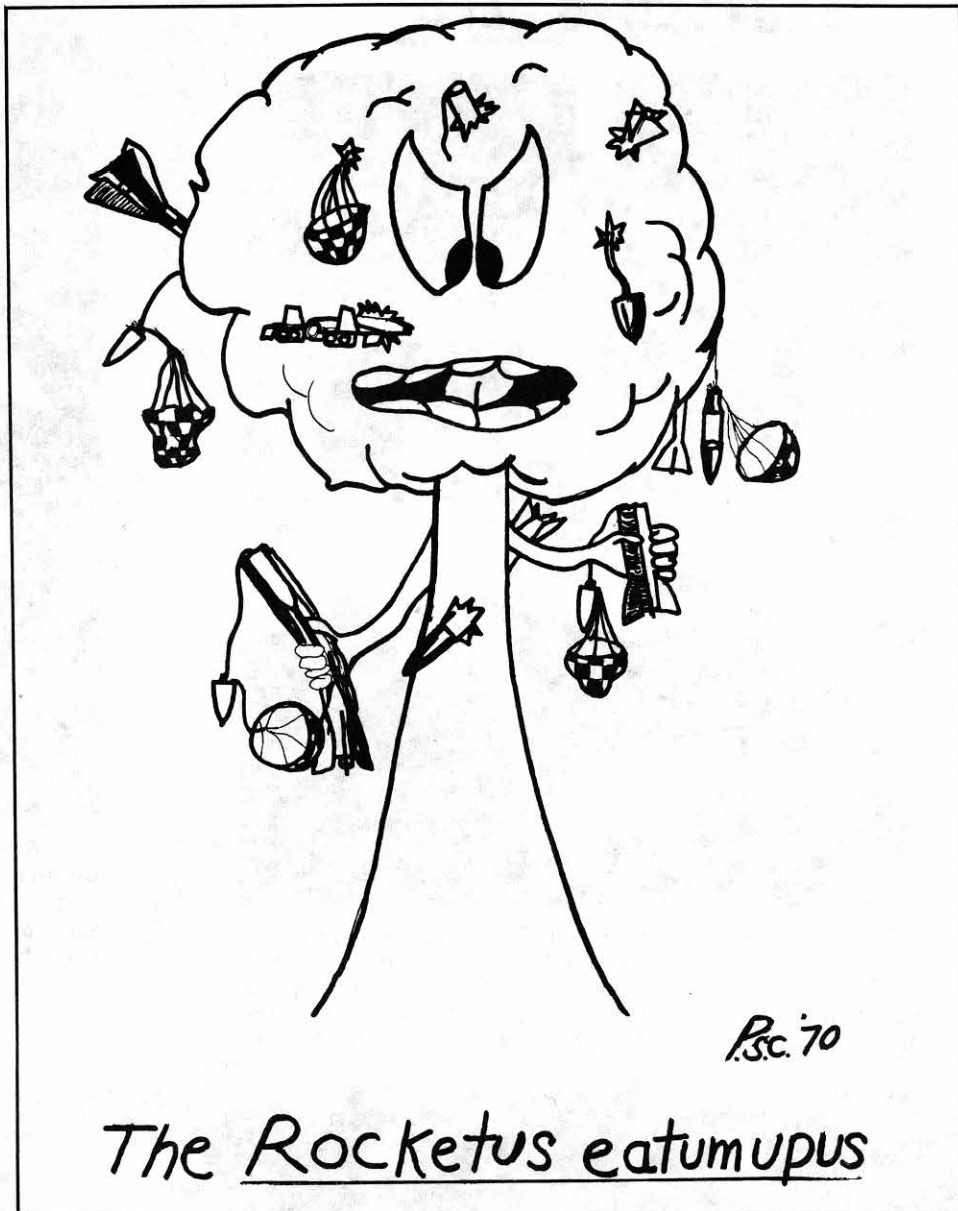

The Rocketus eatumupus

MRN contributors wanted

Got any good ideas for MODEL ROCKET NEWS articles? Sharp photos? Then why not submit them to us for possible publication? Our constant aim is to make MRN a better, more interesting magazine, and you might just be the type of contributor we are looking for.

There's no limit to the areas that can be covered: Technical information, cartoons, anecdotes, club news of unusual interest, etc., with or without photos.

Unless you have it ready, don't send us a finished article--just an outline, and we'll let you know if your proposed story meets our editorial requirements. If you send us photos, please make sure that you pack them between cardboard sheets so that they won't get creased in the mail. Please tell us in your letter if you want your material returned. Address all material to: Editor, MRN, Estes Industries, P.O. Box 227, Penrose, Colorado 81240.

Should your article or photos be used in MRN, we'll reward your efforts and talent with an Estes merchandise certificate, the amount of which will be determined by the MRN editorial staff.

Hope to hear from you soon!

SHUTTER BRIEFS



THE GOLDEN DEPLOYED EXP.

A Lunar sample brought back to Earth last July by Apollo 11 astronauts Neil Armstrong and Ed Aldrin is studied by Estes Industries' President Vernon Estes during the National Science Teachers Association meet in Cincinnati, Ohio. Large photograph in back is that of Aldrin.



At PAR-I regional model rocket contest in West Covina, California, Tony Medina, of Seattle, Washington, helps prep Estes birds for demonstration launches. Rockets that can be seen are Mars Lander, Cherokee-D, and two-stage Shrike.



Somewhat chilled by Pennsylvania winter weather, young rocketeers attending 5th annual Pittsburgh Spring Convention of NAR's Steel City Section nevertheless gather around Wayne Kellner, a member of Estes' Model Development Department and watch him prep a specially-designed demonstration rocket.

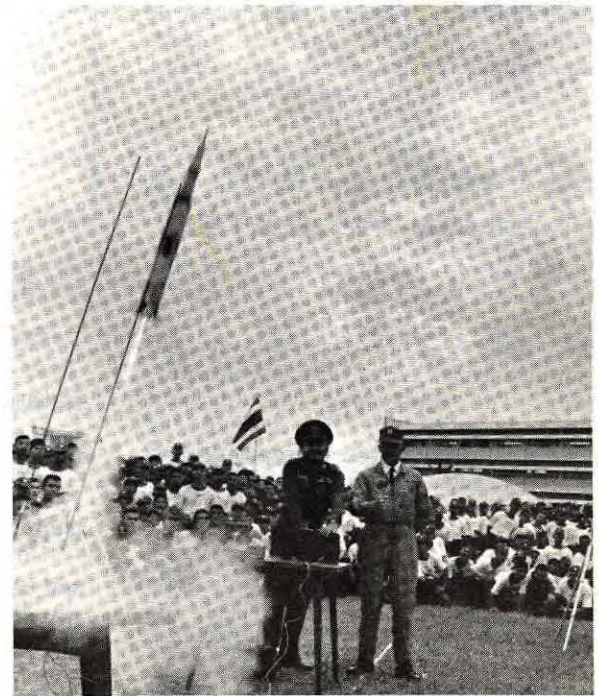

The scene is Bangkok, Thailand, and that's an Estes Saturn V being launched by Colonel Pailboon Sirayakorn, commandant of Bangkok's Armed Forces Academy Preparatory School. Larry Loos, NAR #7127, is the safety officer.