

Equinox^{T.M.}

I N S T R U C T I O N S

© 1993 Custom Rocket Company

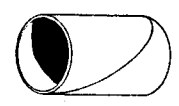
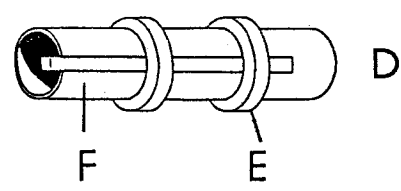
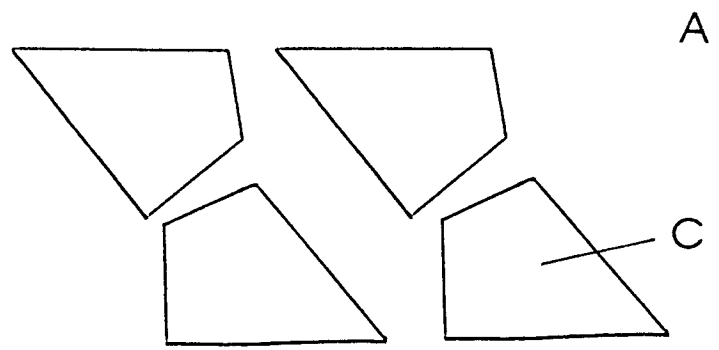
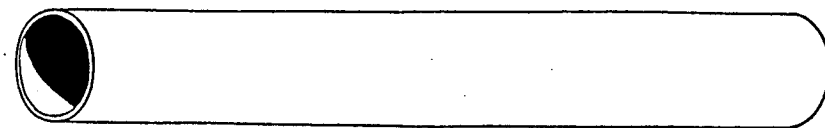
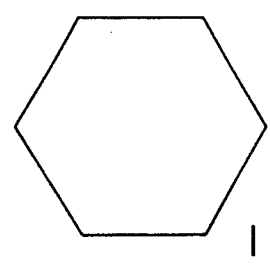
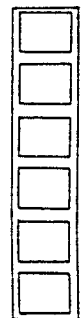
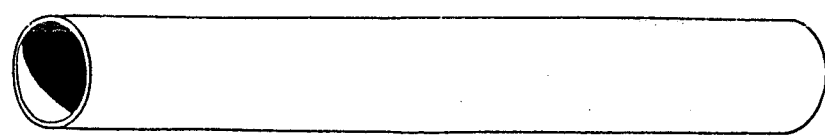
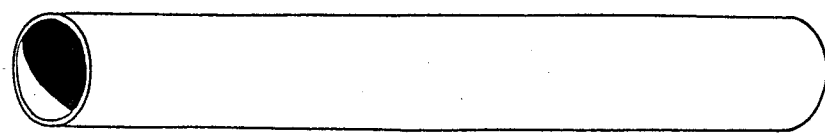
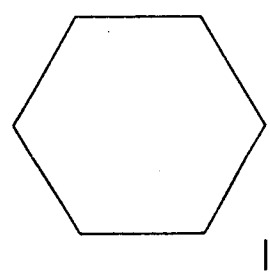
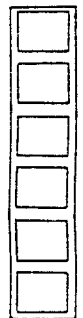
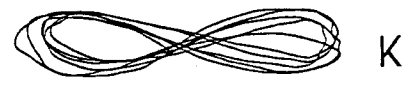
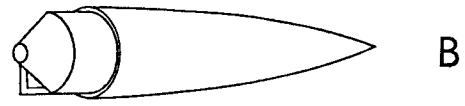

- | | | |
|---|-------------------|------------|
| A | Body tube (4) | (MT-6018) |
| B | Nose cone | (PC-60) |
| C | Balsa | (BAL10016) |
| D | Engine tube | (ET50) |
| E | Centering rings | (CR-50-60) |
| F | Engine clip | (EC-2) |
| G | Shock cord | (SC-2) |
| H | Tube couplers (3) | (TJ-60) |
| I | Parachute (2) | (PK-18) |
| J | Tape disk (2) | (TD-6) |
| K | Shroud lines (2) | (SL-96) |
| L | Decal* | (D-10016) |
| M | Template* | (TEM10016) |
- *Items not shown

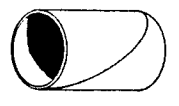
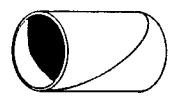
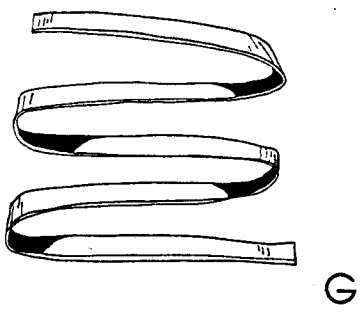

H

1

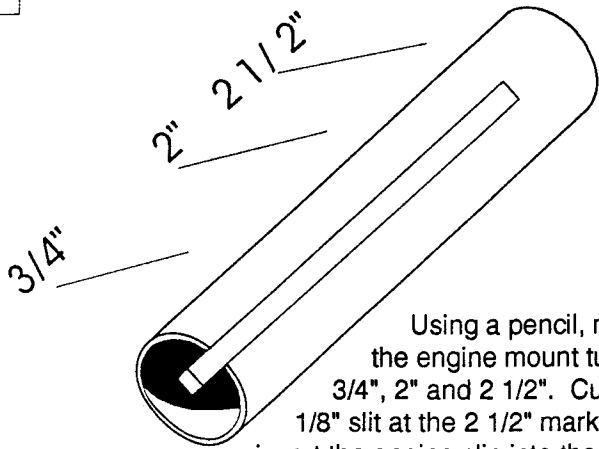

Using a pencil, mark the engine mount tube 3/4", 2" and 2 1/2". Cut a 1/8" slit at the 2 1/2" mark and insert the engine clip into the slot. Take the centering rings and slide them onto the tube at the 3/4" and 2" marks.

2

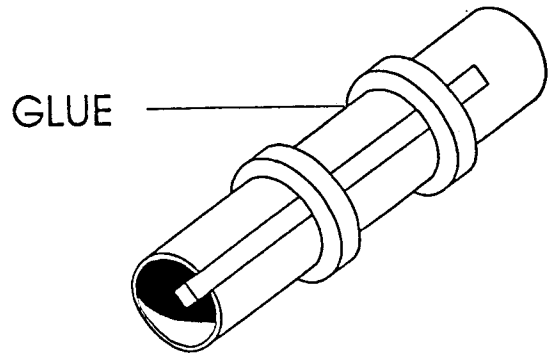

Apply white glue to the joints on all of the rings. Let this motor mount completely dry before going to the next step. It's very important not to rush this step!

3

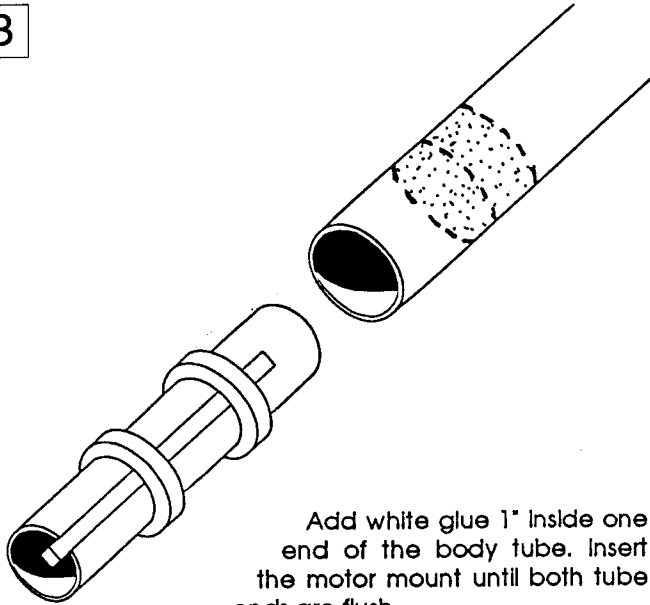

Add white glue 1" inside one end of the body tube. Insert the motor mount until both tube ends are flush.

4

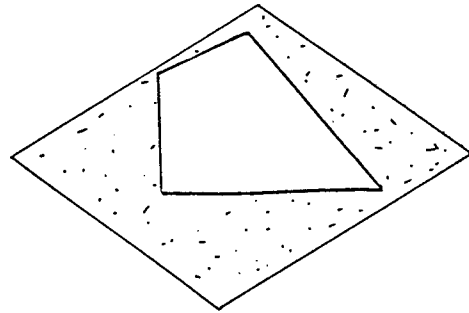

Cut and sand the balsa with fine sandpaper.

5

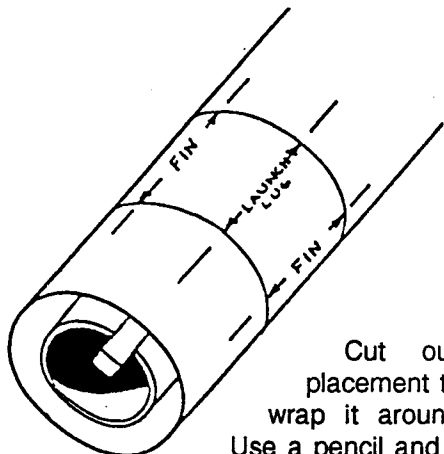

Cut out the fin placement template and wrap it around the tube. Use a pencil and mark the fin and launch lug locations. Notice where the engine clip is in the drawing.

6

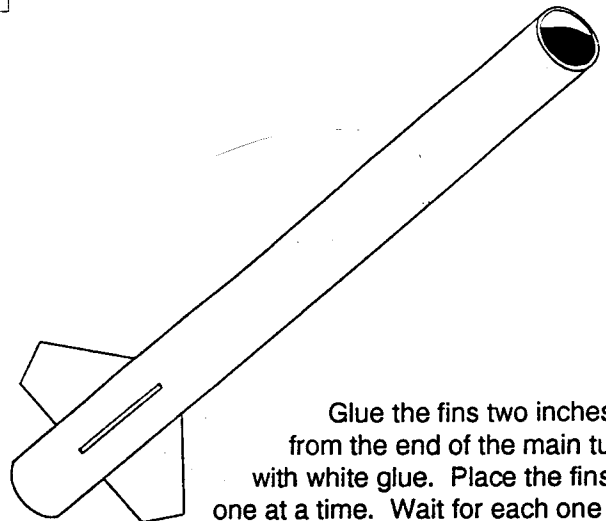

Glue the fins two inches from the end of the main tube, with white glue. Place the fins on one at a time. Wait for each one to dry before applying the next fin.

7

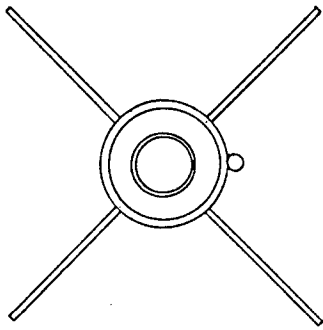

This is how the end view should look.

8

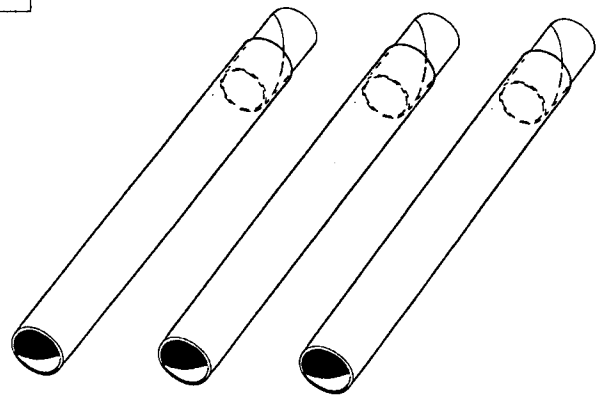

Apply white glue inside the ends of the three tubes and insert the tube couplers so that half of them are showing.

9

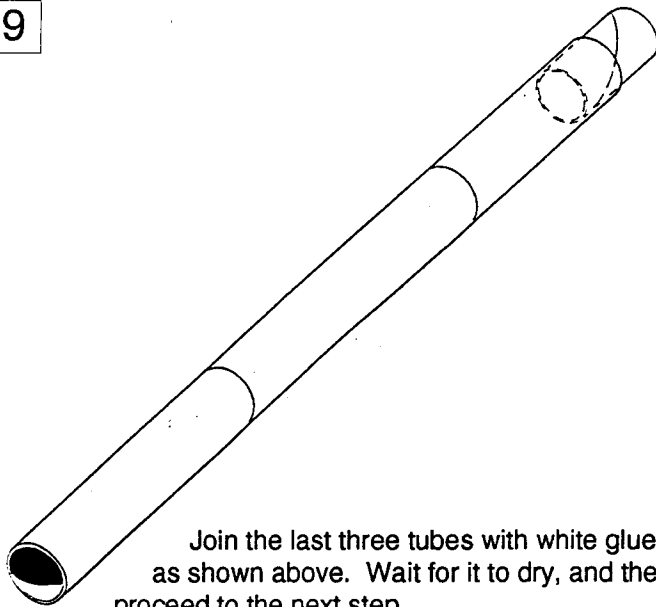

Join the last three tubes with white glue as shown above. Wait for it to dry, and then proceed to the next step.

10

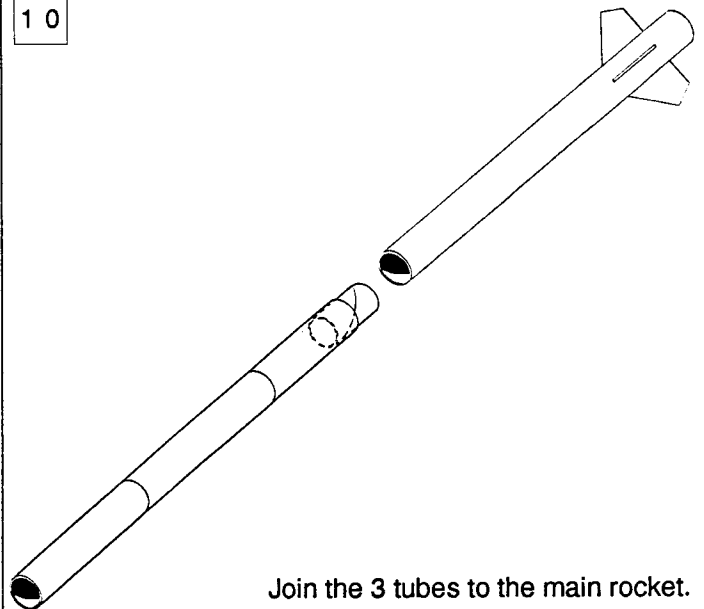

Join the 3 tubes to the main rocket.

11

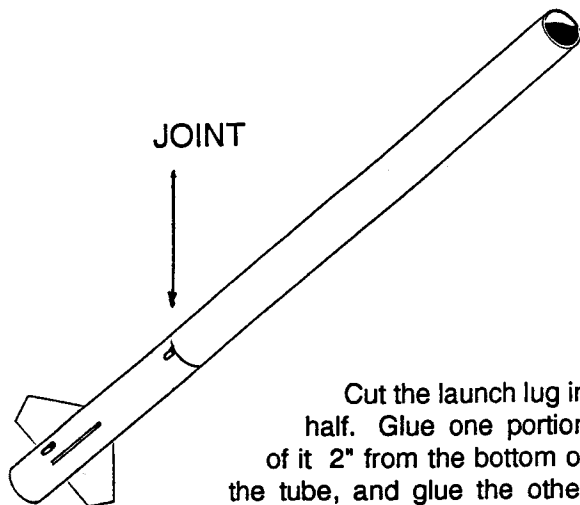

Cut the launch lug in half. Glue one portion of it 2" from the bottom of the tube, and glue the other portion so that it aligns with the first joint of the tube.

12

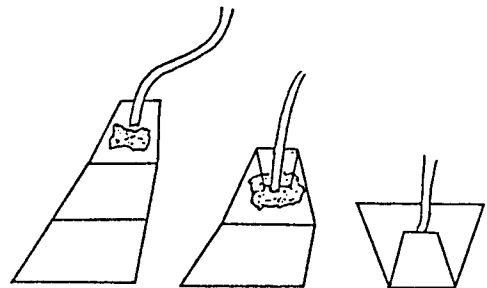

A. Cut out the shock cord mount and apply glue to section 1. Lay the end of the shock cord into the glue.
B. Fold section 1 at the fold line and squeeze with your fingers.
C. Apply glue to the back of section 1 and fold to section 3. Put complete assembly under a heavy object.

13

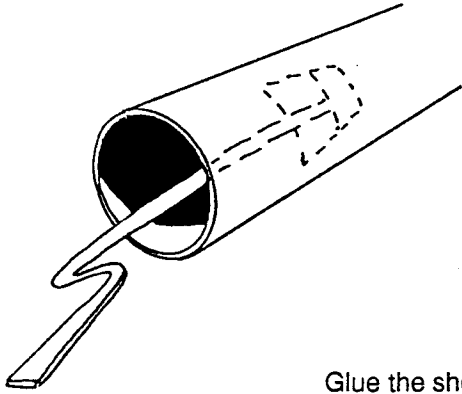

Glue the shock cord mount inside the front of the body tube 1" from the end. Hold the mount until it dries.

14

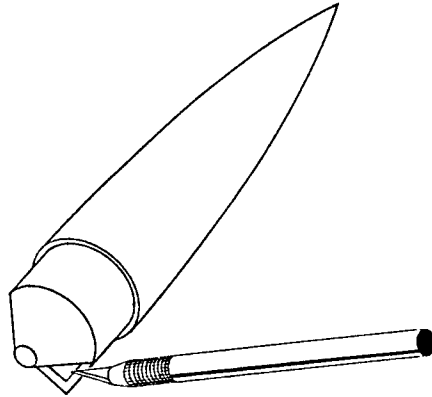

With a razor blade or hobby knife, clear the excess plastic from the screw eye.

15 X2

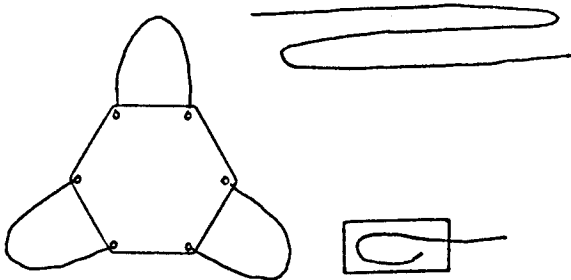

A Cut the shroud line into three equal parts.
 B Attach the end of the shrouds to the tape disks.
 C Tape the disks to the parachute as shown.

16 X2

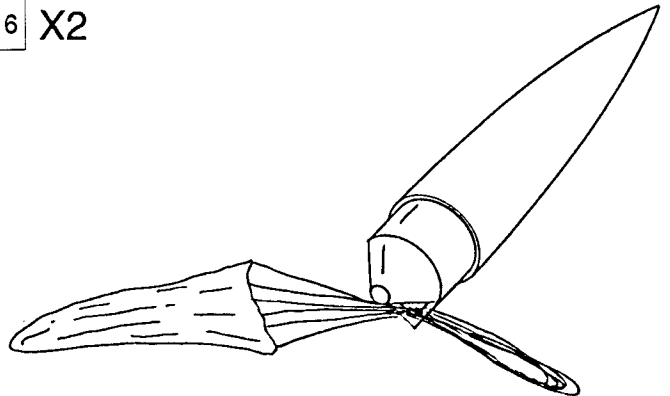

Thread the shroud line loops through the screw eye.

17 X2

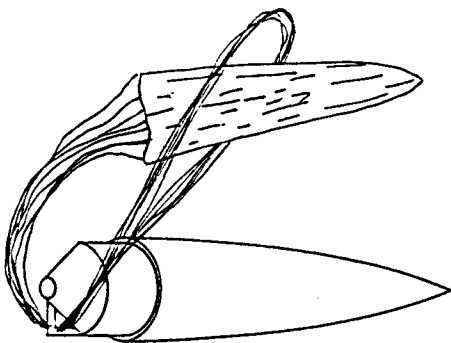

Take the loop ends and pass the parachute through. Pull the parachute tight.

18

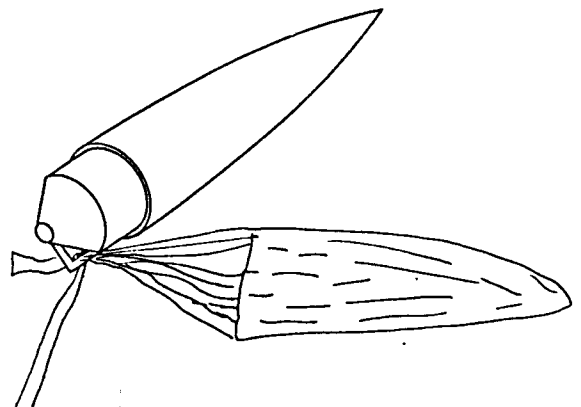

Tie the end of the shock cord to the screw eye.

Equinox Template

		FIN			
		FIN			
		LUG			
		FIN			
		FIN			

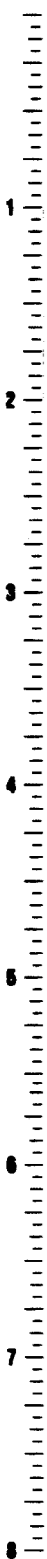
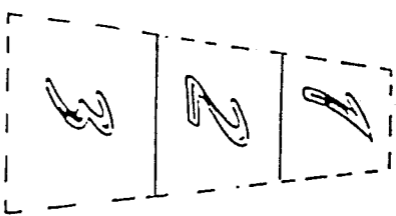

$3/32$ "
BAISA

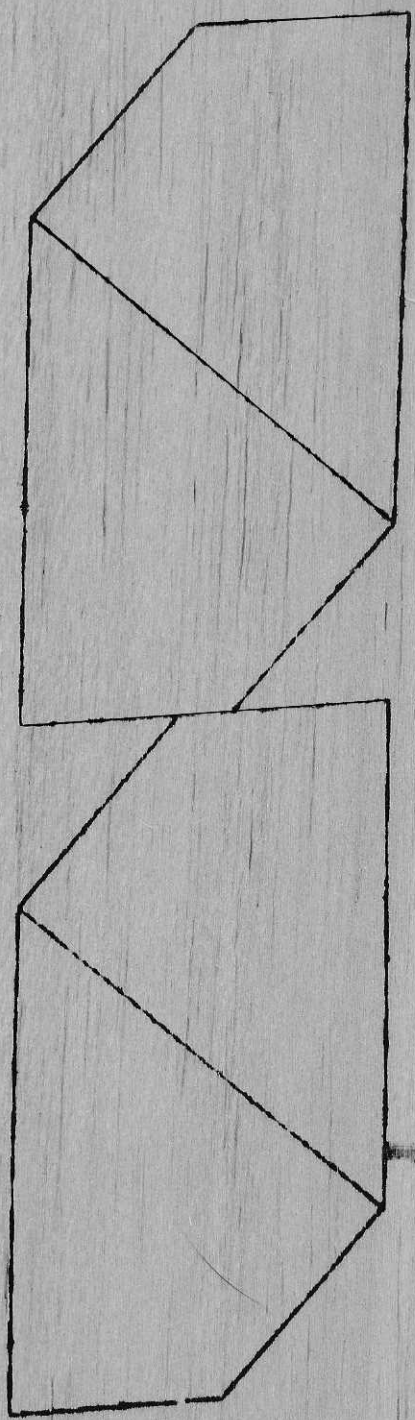

EXON
EXON
ON
ON
NO
NO
OX
OX

8
7
6
5
4
3
2
1