

# SPACE STATION AQUARIUS



Flights  
Over  
800  
Feet!

## FLYING MODEL ROCKET

SKILL LEVEL 3

1-Beginner 2-Intermediate 3-Craftsman  
4-Advanced 5-Expert

- Spectacular Space Station Design
- Two Huge Decal Sheets
- Die-Cut Balsa Parts
- Plastic Nose Cone
- Quick Release Engine Mount
- 18" Parachute Recovery

Length: 20.75 in. (52.7 cm)

Dia.: .976 in. (24.8 mm)

Weight: 1.84 oz. (52 g)

Engine Types: A8-3 (First Flight), B4-2,  
B4-4, B6-2, B6-4, C5-3,  
C6-3, C6-5.

This is a hobby kit requiring assembly.  
Recommended for ages 10 to adult.  
Engines, launch system, glue and finishing  
supplies are not included. Adult supervision  
is suggested for those under 12 years of age  
when flying model rockets.



A DAMON COMPANY

#1902



ESTES INDUSTRIES  
PENROSE, CO 81240 USA



# SPACE STATION AQUARIUS

SKILL LEVEL 3 - RECOMMENDED FOR THE EXPERIENCED MODEL BUILDER

RECOMMENDED ENGINES: A8-3, B4-2, B4-4, B6-2, B6-4  
C5-3, C6-3, C6-5  
First Flight A8-3

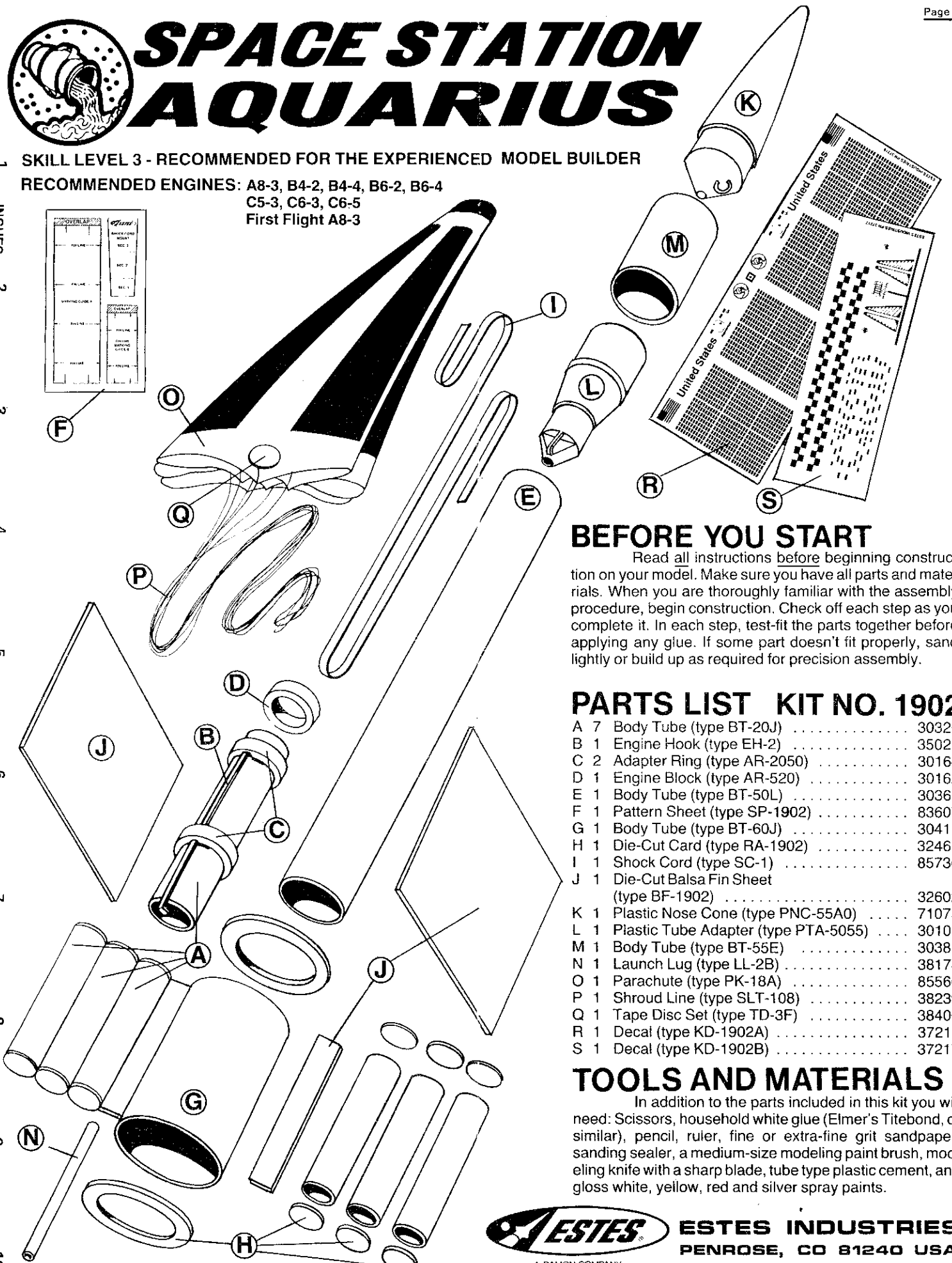
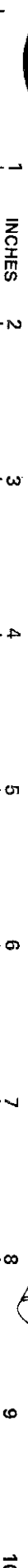
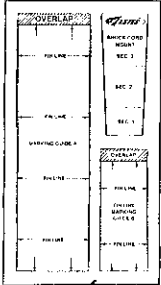

## BEFORE YOU START

Read all instructions before beginning construction on your model. Make sure you have all parts and materials. When you are thoroughly familiar with the assembly procedure, begin construction. Check off each step as you complete it. In each step, test-fit the parts together before applying any glue. If some part doesn't fit properly, sand lightly or build up as required for precision assembly.

## PARTS LIST KIT NO. 1902

A	7	Body Tube (type BT-20J)	30326
B	1	Engine Hook (type EH-2)	35025
C	2	Adapter Ring (type AR-2050)	30164
D	1	Engine Block (type AR-520)	30162
E	1	Body Tube (type BT-50L)	30366
F	1	Pattern Sheet (type SP-1902)	83607
G	1	Body Tube (type BT-60J)	30412
H	1	Die-Cut Card (type RA-1902)	32461
I	1	Shock Cord (type SC-1)	85730
J	1	Die-Cut Balsa Fin Sheet (type BF-1902)	32602
K	1	Plastic Nose Cone (type PNC-55A0)	71075
L	1	Plastic Tube Adapter (type PTA-5055)	30101
M	1	Body Tube (type BT-55E)	30381
N	1	Launch Lug (type LL-2B)	38178
O	1	Parachute (type PK-18A)	85566
P	1	Shroud Line (type SLT-108)	38239
Q	1	Tape Disc Set (type TD-3F)	38406
R	1	Decal (type KD-1902A)	37216
S	1	Decal (type KD-1902B)	37217

## TOOLS AND MATERIALS

In addition to the parts included in this kit you will need: Scissors, household white glue (Elmer's Titebond, or similar), pencil, ruler, fine or extra-fine grit sandpaper, sanding sealer, a medium-size modeling paint brush, modeling knife with a sharp blade, tube type plastic cement, and gloss white, yellow, red and silver spray paints.



A DAMON COMPANY

**ESTES INDUSTRIES**  
PENROSE, CO 81240 USA

# ASSEMBLY INSTRUCTIONS

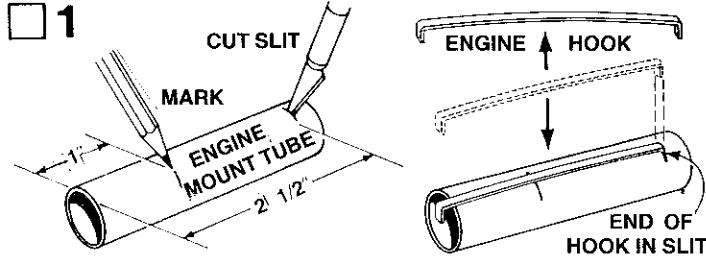

Mark one engine mount tube (part A) at 1" and 2-1/2" from one end. Cut a 1/8" long slit at the 2-1/2" mark. Gently bend the engine hook (part B) so that it bows upward very slightly in the middle. (Study the drawing.—Don't bend the wrong way.) Insert one end of the engine hook into the slit in the tube.

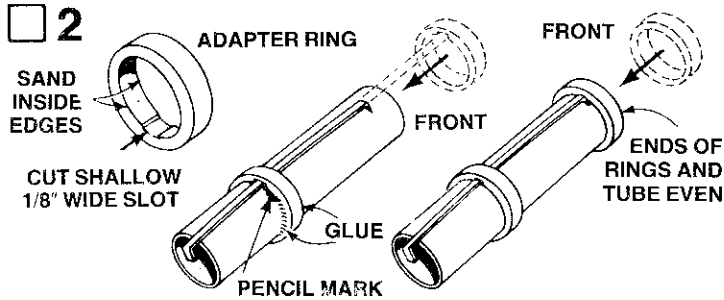

Sand the inside edges of the two adapter rings (part C) to remove burrs. The rings should slide easily onto the engine mount tube. Cut a very shallow 1/8" wide slot inside one adapter ring so it will fit over the engine hook. Slip the ring onto the front end of the engine mount tube and slide it down to the 1" mark. Make sure the engine hook runs straight down the tube, then apply glue to both sides of this adapter ring. Apply glue around the front end of the engine mount tube and slide the remaining adapter ring into place (front of ring even with the end of the tube). Glue the engine block (part D) into the front of the tube against the end of the engine hook.

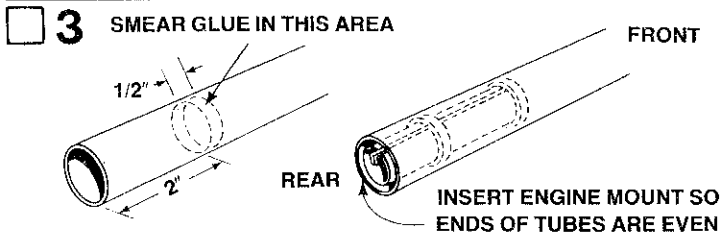

The engine mount unit will be pushed into place so that the rear of the engine mount unit (end with engine hook projecting) is even with the rear of the body tube. Test-fit the engine mount unit several times by smoothly inserting and removing it. Once this can be smoothly and easily done, remove the engine mount unit. Apply a ring of glue around the inside of the rear of the main body tube (part E) about 2" to 2-1/2" from the end of the tube. Make certain that the engine hook is to the rear and insert the engine mount unit with one smooth motion. Do not pause or the glue may "lock" with the engine mount unit in the wrong place.

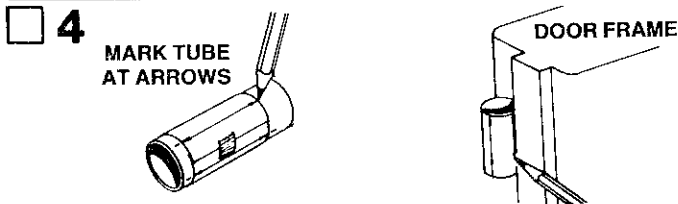

Cut out the large tube marking guide from the pattern sheet (part F) and wrap it around the large BT-60J body tube (part G). Align the guide marks and tape the guide together. Mark the body tube at each of the arrow points. Remove the guide. Draw straight lines connecting each pair of marks. A door frame inside edge can be used for a guide as shown. Extend the lines the entire length of the tube. Repeat the process for the small tube marking guide and the six remaining BT-20 body tubes (part A).

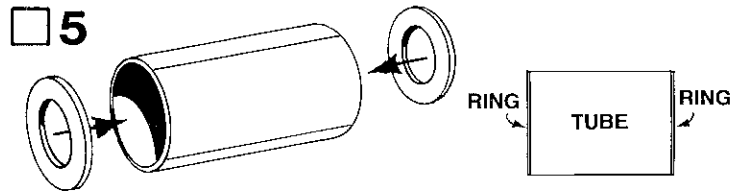

Remove the two large rings from the die-cut card (part H). Glue a ring to each end of the BT-60 body tube so that the glossy side faces out and the edges of the rings are even all the way around. Wipe off any excess glue.

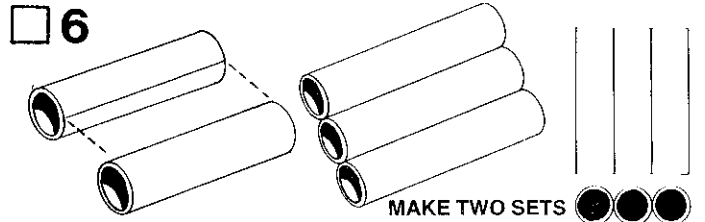

Glue three BT-20 body tubes together on a flat surface matching up the guide marks as shown. Be sure the ends of the tubes are even. Repeat this process to complete two sets of missile pods.

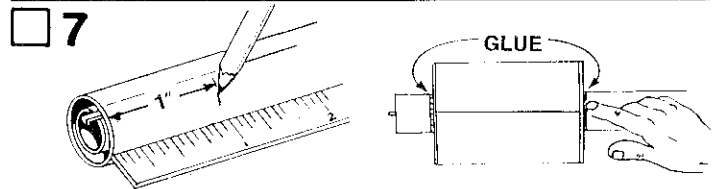

Mark the main body tube 1" from the rear. Slide the BT-60 unit onto the main body tube so that the rear ring is at the mark. Apply glue around both ring tube joints. Smooth out the glue with your finger.

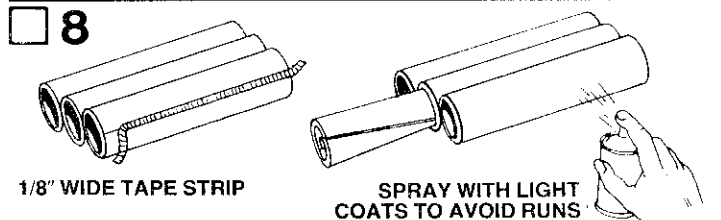

Cut two strips of masking tape 1/8" wide and at least 3" long. Apply the tape along one guide line of each cluster of missile pods as shown. Press the edges of the tape down firmly. Spray paint the units gloss yellow using several light coats of paint. Use a piece of rolled paper to support the pods while painting.

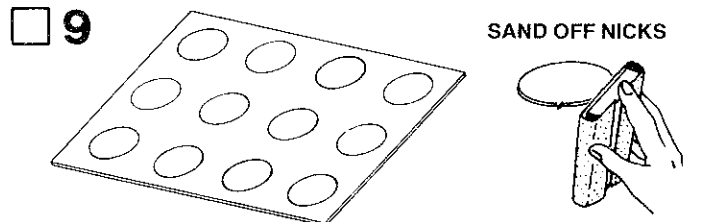

Remove the twelve small discs from the die-cut card. Lightly sand the edges as necessary to remove any nicks. Place the discs on a large piece of paper glossy side up. Spray paint the discs with several light coats of gloss red spray paint. Be sure to paint the sides of the discs as well as the tops.

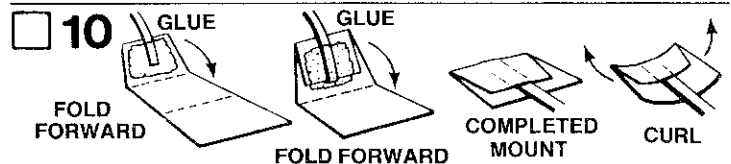

Cut out the shock cord mount from the pattern sheet. Fold on dotted lines, then unfold and apply glue to Section 1. Lay the end of the shock cord (part I) into the glue. Fold over and apply glue to the back of Section 1 and the exposed portion of Section 2. Fold again to complete the mount. Curl the edges of the mount up so it will match the contour of the body tube and hold with your fingers until the glue sets.



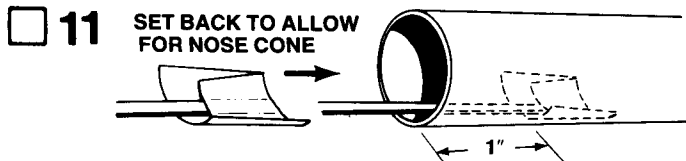

Apply glue to the side of the shock cord mount which will go against the body tube. Press the shock cord mount firmly into position about 1" to 2" from the front edge of the tube to allow clearance at the front of the tube for the adapter to socket into place. Slide the shock cord mount into the tube and press it firmly against the body tube. To insure a good bond use a stick or your finger to smear a film of glue over the mount and surrounding area in the body tube. Again firmly press the shock cord mount against the body tube and rub the glue over the mount and the body tube surface around it.

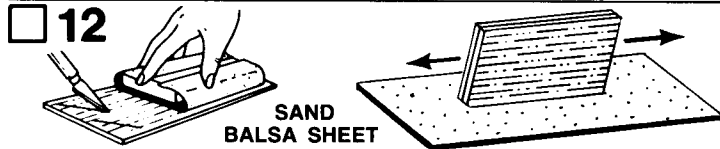

Fine-sand the balsa die-cut sheet (part J). Free the fin edges with a sharp knife, then carefully remove the fins from the sheet. Stack the fins as shown and sand all four sides as illustrated. Sand the edges of each fin square.

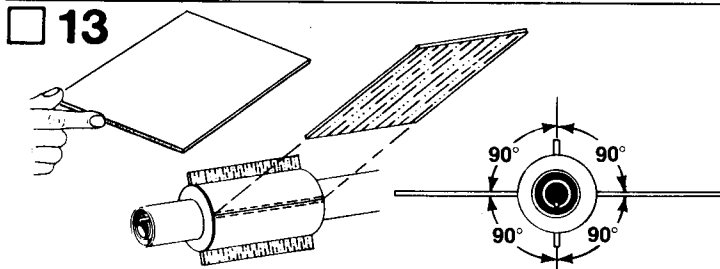

Rub glue into the root edge of each fin and allow to dry. Apply glue to the fins again and position the fins on the alignment lines as shown. Adjust the fins so that they project straight away from the body tube. NOTE: It is best to glue on the small fins first then the large fins, waiting a few minutes between each to allow the glue to set...Do not set the rocket on its fins while the glue is wet.

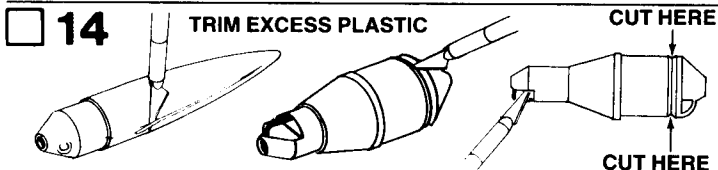

Trim or sand any excess plastic from around the edges of the nose cone (part K) and the tube adapter (part L). Using the groove as a guide, cut off the large end piece of the tube adapter as shown. Also remove any plastic from the molded eyelet on the other end of the tube adapter. Wash the nose cone and tube adapter with lukewarm soapy water, rinse well and let dry.



Smear tube type plastic cement inside of each end of the BT-55 body tube (part M). Push the nose cone into one end and the tube adapter into the other end of the tube. Wipe off any excess glue. The joints may be filled with modeling putty after the glue dries, if desired.

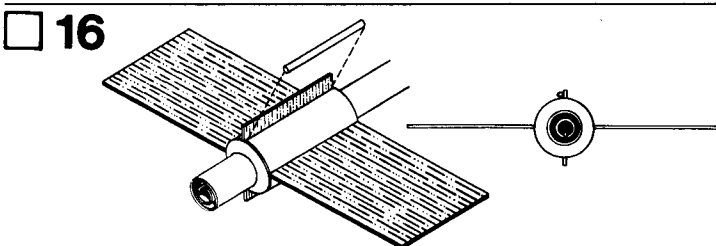

Glue the launch lug (part N) to the front of the large body tube at one of the small fin joints as shown.

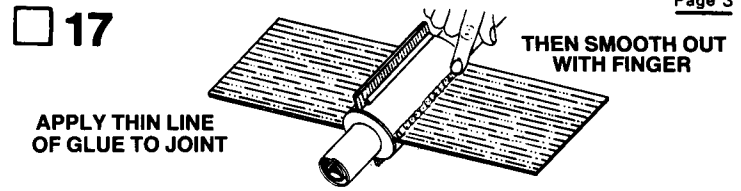

When the glue on the fin joints has dried, apply a glue reinforcement to each fin/body tube joint. Holding the model level, apply a line of glue to both sides of each fin joint and on both sides of the launch lug. Smooth out the glue with your finger. IMPORTANT—Keep the model level until the glue dries.

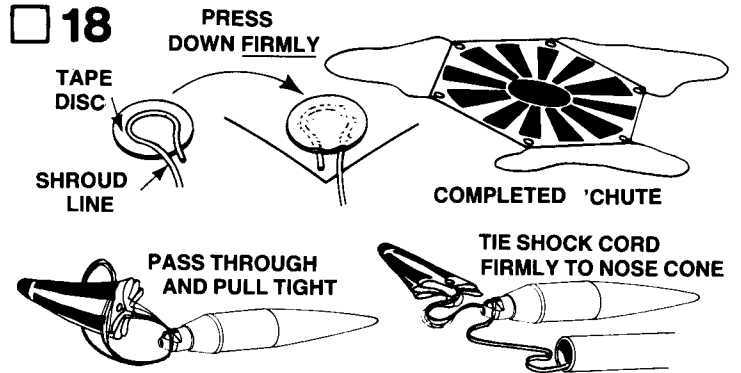

Cut out the parachute (part O) on its edge lines. Cut three equal lengths of shroud line (part P). Attach line ends to the top of the parachute with tape discs (part Q) as shown. Form a small loop in the end of a shroud line. Holding loop, gently center loop inside tape disc on the sticky side. Then carefully press tape disc onto its proper place on the top of the parachute. Firmly press the tape disc into place until both tape disc and parachute material are molded around the shroud line loop. Repeat for other shroud line ends and tape discs. Pass the shroud line loops through the loop on the tube adapter. Pass the parachute through the loop ends and pull the lines tight against the tube adapter. Tie the free end of the shock cord firmly to the tube adapter loop. A square knot or strong double knot should be used.

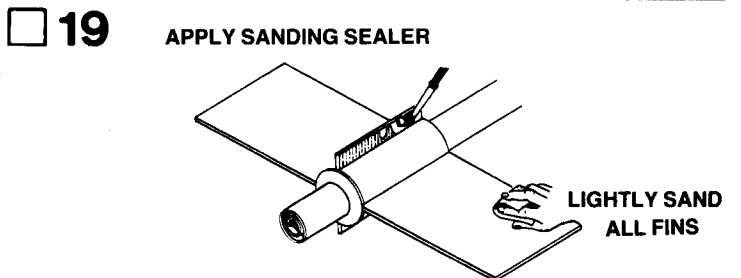

Proceed with this step only after the glue has thoroughly dried. Proper application of sanding sealer makes the rocket look better and reduces drag so that the rocket will fly higher. However, this step is not essential to make a safe rocket. Apply a coat of sanding sealer to each fin. When sealer is dry, lightly sand all the sealed surfaces. Repeat sealing and sanding process until balsa grain is filled and smooth.

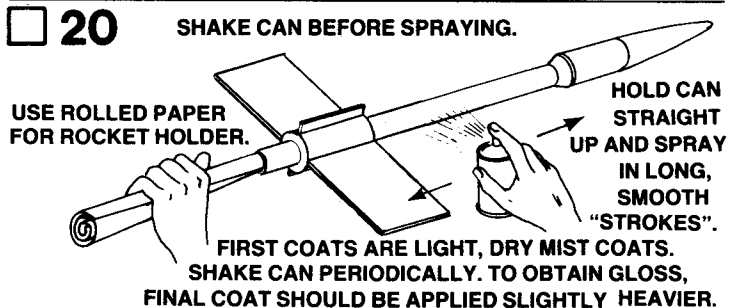

After the sanding sealer is completely dry, paint the entire model gloss white. Let this coat dry overnight. Follow instructions on spray can for best results. We recommend spray enamel. Do not paint the model with lacquer paint. Lacquer will mar the finish of the plastic nose cone. Spray the model with several light coats of paint to avoid "runs".

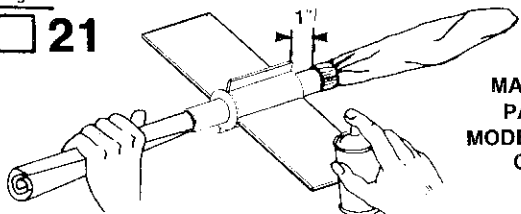
**21**

**MASKING TAPE AND PAPER PROTECT MODEL FROM SECOND COLOR SPRAY.**

After the gloss white paint has thoroughly dried (overnight is best), apply masking tape and paper to the rocket to cover the front from 1" in front of the large body tube as shown. After making sure the edges are tightly sealed, spray the rear of the rocket silver. After the paint has dried remove the paper and tape.

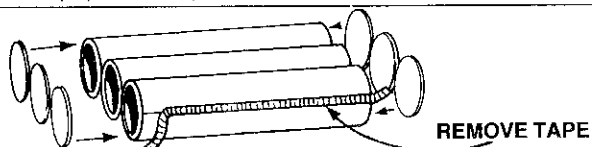
 **22**

Remove the masking tape from the missile pods. Glue a disc to each end of each pod, wiping off any excess glue.

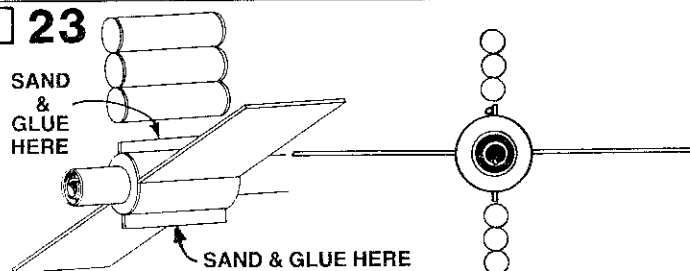
 **23**

Sand the tip edges of the two small fins as shown to remove the paint. Apply glue to the edges and let dry. Glue the missile pods to the small fins along the unpainted sections so that they project straight away from the fins. Do not set the model on the missile pods until the glue has thoroughly dried.

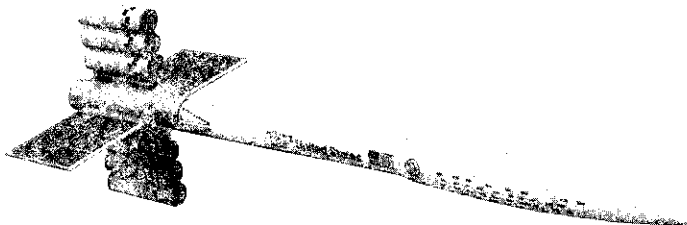
 **24**

When all paint is dry, apply the decals (part R&S) in the positions shown. (A) Cut only one decal at a time from sheet. (B) Submerge decal in lukewarm water until decal slides on backing paper (usually 15 to 30 seconds). (C) Gently slide decal from backing paper onto model. (D) Move decal into exact position and carefully blot away excess water with a soft cloth. (E) If the decal "sticks" before you have it in position, apply water over the decal with a brush. This will permit the decal to be moved. (F) Smooth out all wrinkles and air bubbles before the decal dries. We recommend that the completed model be sprayed with Testor's "Gloss-Cote". This is a clear spray paint that protects the model's finish.

To launch your rocket you will need the following items:

- An Estes model rocket launching system
- Flame resistant recovery wadding (Estes Cat. No. 2274)
- Estes A8-3, B4-2, B4-4, B6-2, B6-4, C5-3, C6-3, C6-5 model rocket engines. Use an A8-3 engine for your first flight.

Be sure to follow the HIAA-NAR\* Model Rocket Safety Code when carrying out your model rocket activities.

\*HIAA—Hobby Industry of America

\*NAR—National Association of Rocketry

## COUNTDOWN CHECKLIST

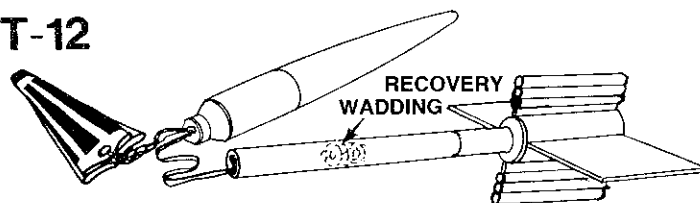
**T-12**

Pack 5 or 6 squares of loosely crumpled recovery wadding into the body tube. Usually this will fill the body tube for a distance equal to about 1-1/2 times its diameter.

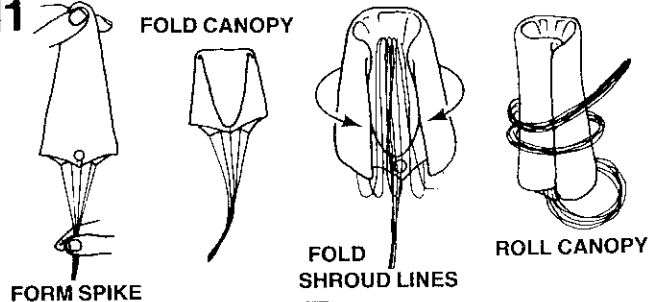
**T-11**

Hold the parachute at its center and pass the other hand down it to form a "spike" shape. Fold this spike in half. Fold shroud lines back along parachute and then back down to lower edge of parachute to reduce length of shroud line "left over". Roll parachute into tube shape to fit easily into body. Any remaining shroud line should be loosely wrapped around parachute. Pack 'chute into the body tube on top of the wadding. Pack the shroud lines and shock cord in on top of the parachute and slip the nose cone into place.

**NOTE: DO NOT** pack parachute until you are actually ready to launch. For maximum parachute reliability, lightly dust the 'chute with ordinary talcum powder before each flight, especially in cold weather.

**T-10**

Select an engine and install an igniter as directed in the engine instructions. Insert engine into rocket engine mount. Engine hook must latch securely over end of the engine.

**T-9** Disarm the launch panel—REMOVE SAFETY KEY!

**T-8**

Wrap a piece of tape around the launch rod to support the rocket about 2" above the blast deflector. Slide launch rod through rocket launch lug and place rocket on launch pad. Make sure the rocket slides freely on the launch rod. Clean the micro-clips and attach them to the igniter wires. Arrange the clips so they do not touch each other or the metal blast deflector. Attach clips as close to protective tape on igniter as possible.

**T-7** Clear the launch area. Alert recovery crew and trackers. Check for low flying aircraft and unauthorized persons in the recovery area.

**T-6** Arm the launch panel—INSERT SAFETY KEY!

## 5-4-3-2-1-LAUNCH!!

Repeat Countdown Checklist for each flight.

## MISFIRE PROCEDURE

Disarm the launch panel. Wait one minute before approaching the rocket on the launch pad. Remove the rocket, clean the igniter residue from the nozzle of the engine, and carefully install a new igniter. Repeat the Countdown Checklist.

Failure of the rocket engine to function properly is nearly always caused by a failure to install the igniter correctly. This failure permits the igniter to heat and burn into two pieces without igniting the engine.

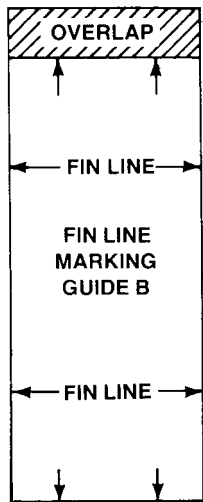
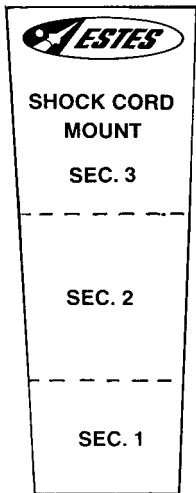
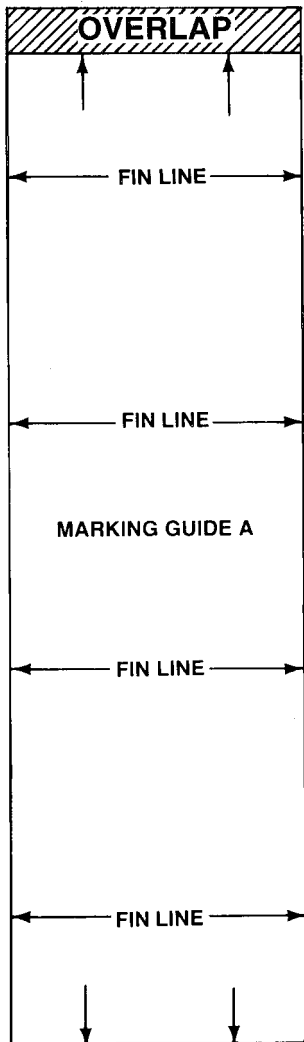

ESTES INDUSTRIES

PN 83607

**Estes Kit 1902 Space Station Aquarius  
Marking Guides  
Template 1 of 2**

**CR-2060 Centering Rings (BT-20 into BT-60). Two needed. Make from thick cardstock.**

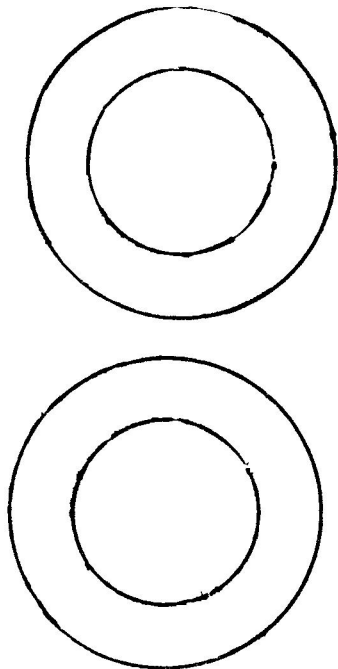

**A total of twelve thick cardstock disks are needed. These are the same size as the center-punch areas of CR-2055 or CR-2060 centering rings.**

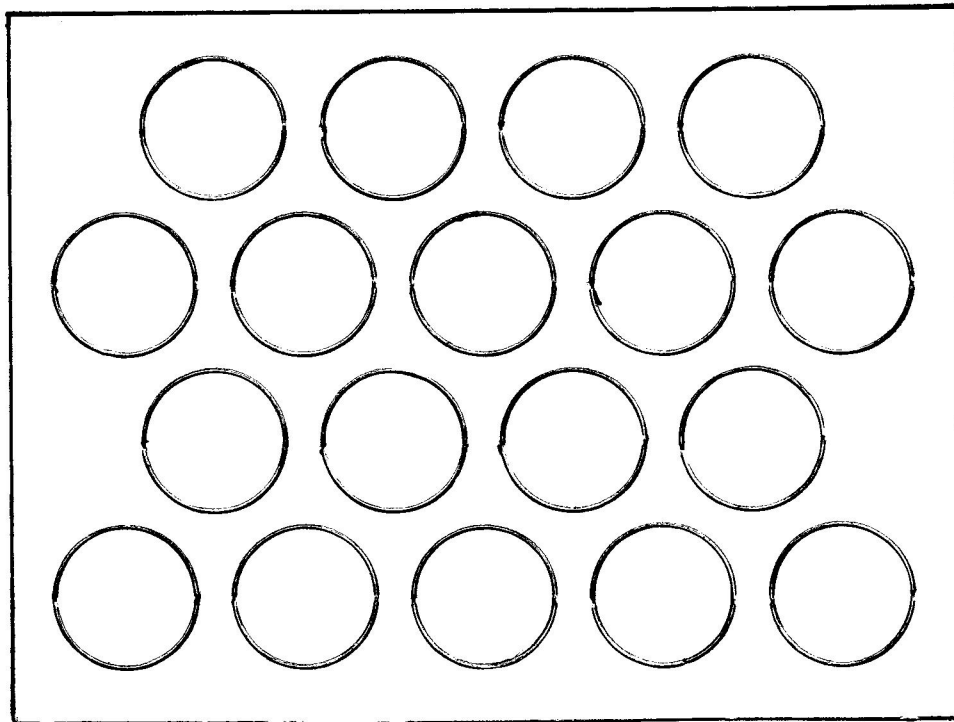

**Estes Kit 1902  
Space Station Aquarius**

**Fin Templates: 3/32" Balsa**

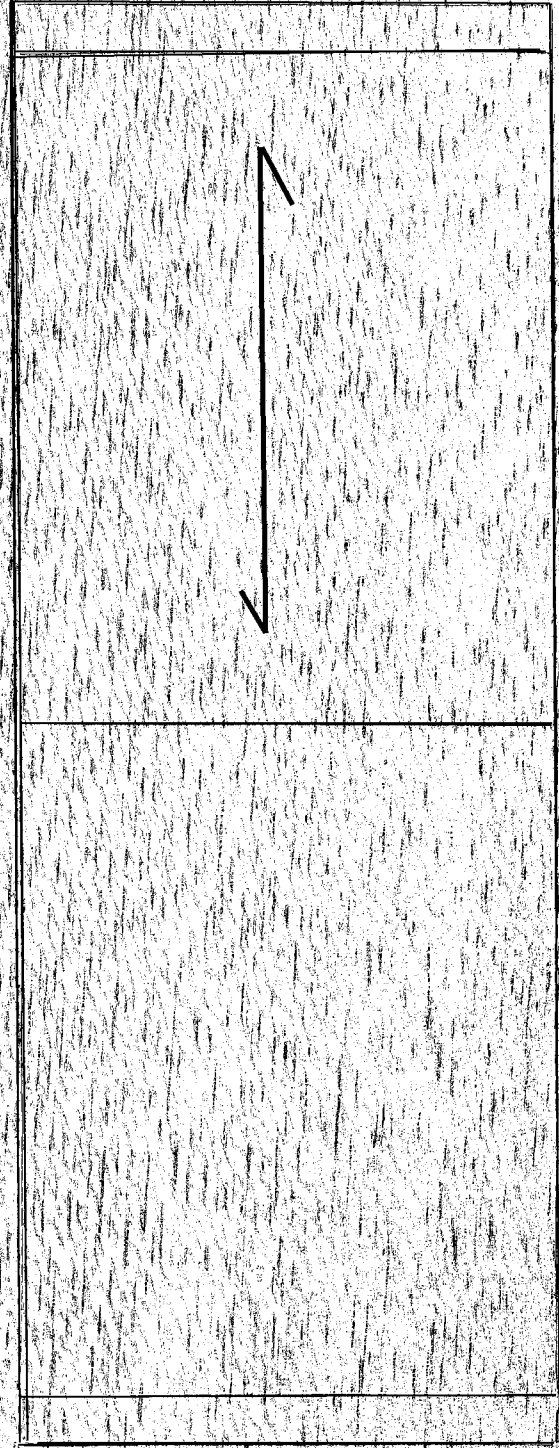
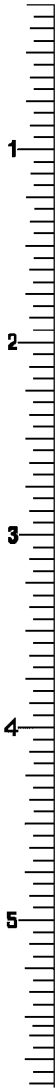



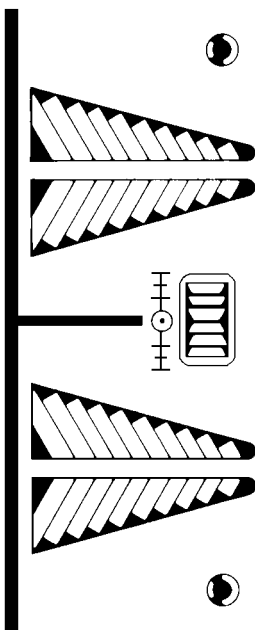
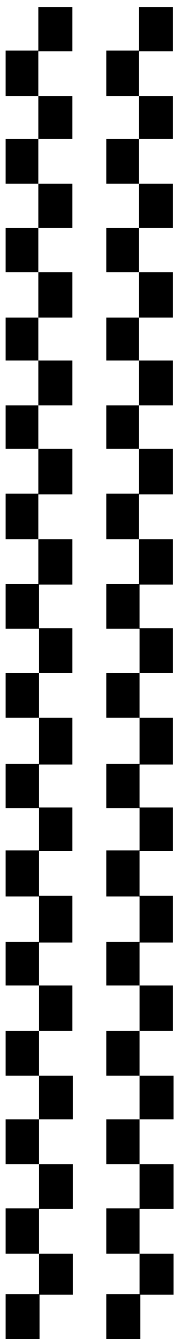
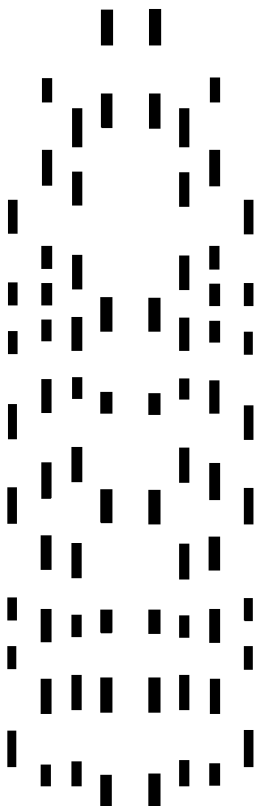

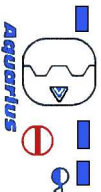

United States

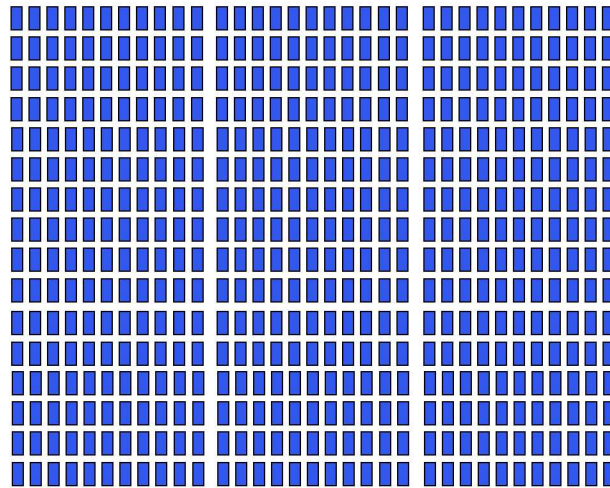
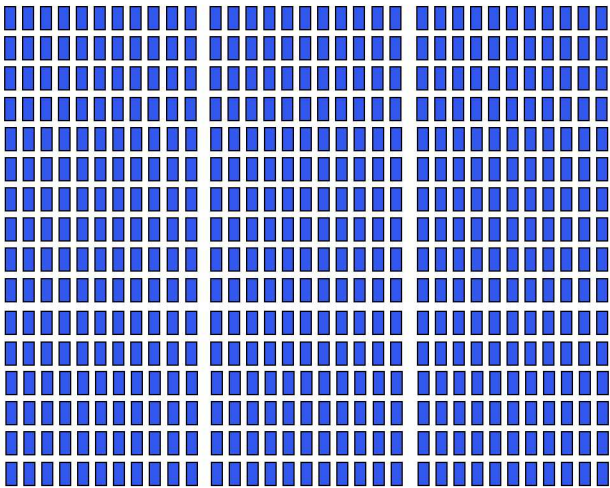

ESTES INDUSTRIES PN 37216



United States

